

A[®]-line

endoscopy

Urologie

Urology

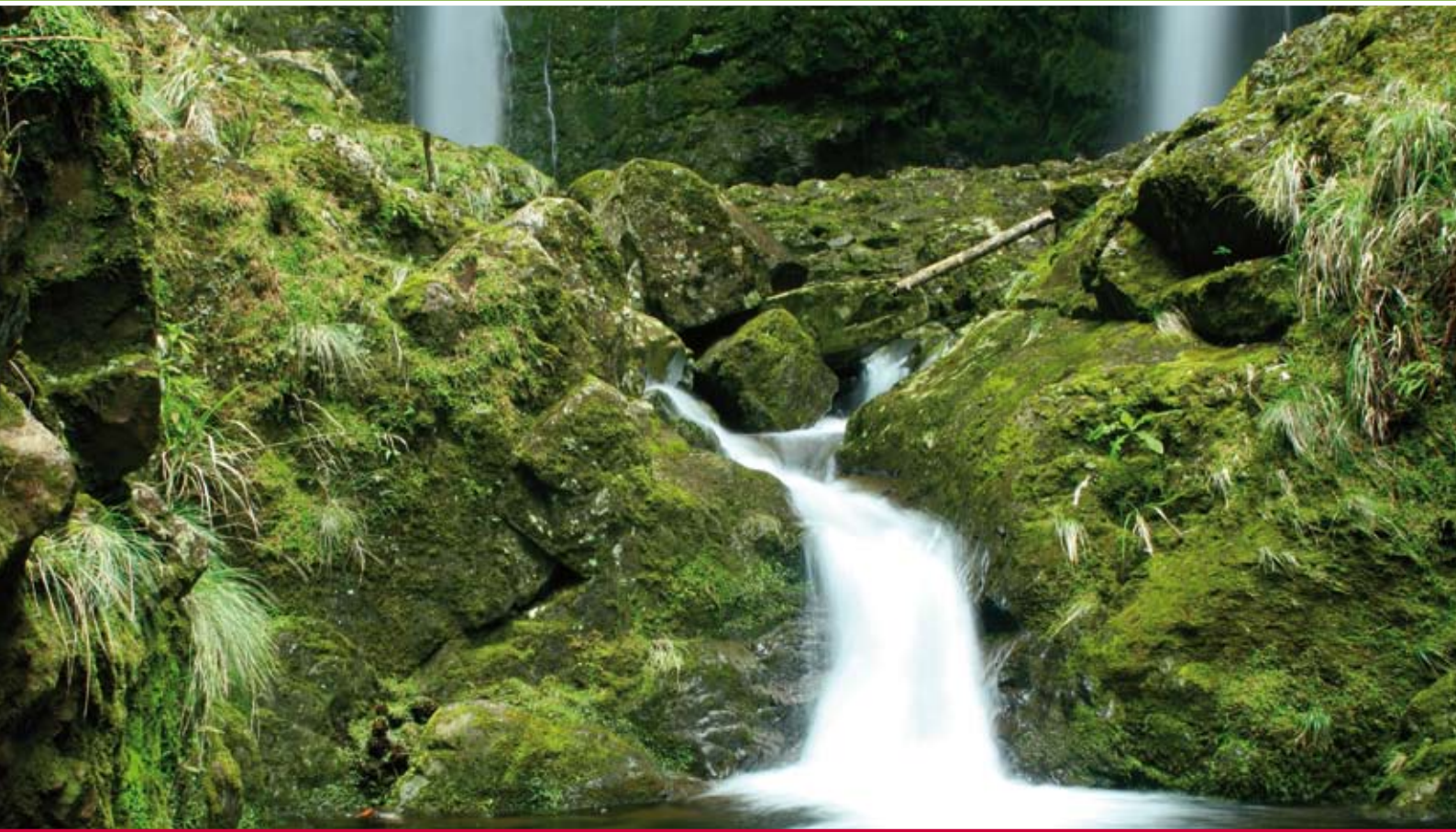

...we can do it!

Inhaltsübersicht

Contents

Endoskope und Kaltlichtkabel /-Adapter <i>Endoscopes and Cold Light Cables / Adaptors</i>	Seite / Page	05 – 13
Cysto-Urethroskopie / Cysto-Urethroscopy	Seite / Page	14 – 30
Resektoskopie / Resectoscopy	Seite / Page	32 – 49
Lasieranwendungen / Laser Applications	Seite / Page	50 – 74
Urethrotomie / Urethrotomy	Seite / Page	58 – 69
Uretero-Renoskopie / Uretero-Renoscropy	Seite / Page	70 – 77
Perkutane Nephroskopie / Percutaneous Nephroscopy	Seite / Page	80 – 87
Kinder Urologie / Pediatric Urology	Seite / Page	88 – 109
Instrumente / Instruments	Seite / Page	110 – 117
Geräte / Equipment	Seite / Page	118 – 121
Zubehör / Accessories	Seite / Page	122 – 127
Pflegeprodukte / Maintenance Products	Seite / Page	128 – 131



...we can do it!

Symbole

Symbols



Endoskop-Durchmesser
Endoscope diameter



Verriegelungssystem am Schaft
Interlocking system at sheath

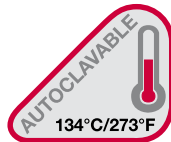

autoklavierbar
autoclavable

Maßeinheiten

Measurements

Millimeter / *Millimetre* mm

Inch	1 inch = 25,4 mm
	1 mm = 0,039 inch

French	1 Fr. = 0,33 mm
	1 mm = 3,0 Fr.

Charrière	1 Charr. = 0,33 mm
	1 mm = 3,0 Charr.

Endoskope

Endoscopes

A-line
endoscopy



UROLOGY



...we can do it!



Technische Merkmale

Technical Features

- ▲ **Perfektes, ergonomisches Design**
Perfect, ergonomic design
- ▲ **Hergestellt aus korrosionsfreiem Edelstahl**
Made out of non-corrosive stainless steel
- ▲ **Autoklavierbar (134°C/273°F)**
Autoclavable (134°C/273°F)
- ▲ **Extrem widerstandsfähig & beständig**
Extremely resistant & durable
- ▲ **Distale & proximale Decklinsen aus Saphirglas hergestellt**
> **Kratzresistent!**
Distal & proximal lenses are made of Sapphire glass
> scratch resistant!
- ▲ **Verzerrungsfreies & kristallklares Bild**
Distortion-free & crystal clear image
- ▲ **Mechanische Komponenten & Verbindungen sind lasergeschweißt oder geklebt**
Mechanical components & connections are laser-welded or glued
- ▲ **Kompatibel auch mit anderen Herstellern**
Compatible also with other brands
- ▲ **Verschiedene Blickrichtungen farblich klar gekennzeichnet**
Various viewing directions clearly marked with colour-codes
- ▲ **2 Jahre Garantie**
2 years guarantee
- ▲ **Exzellenter Reparatur- & Kundendienst-Service**
Excellent repair & after sales service



Endoskope

Endoscopes

A-line
endoscopy

Endoskope, starr

Endoscopes, rigid

2,7 – 4,0 mm



Durchmesser Diameter	Blickrichtung Direction of view	Kennfarbe Colour code	Nutzlänge Working length	Bestell-Nr. Ordering number
	0°	grün / green	302 mm	AER300-040-000
	12°	schwarz / black	302 mm	AER300-040-012
	30°	rot / red	302 mm	AER300-040-030
	70°	gelb / yellow	302 mm	AER300-040-070
	0°	grün / green	302 mm	AER150-029-000
	30°	rot / red	302 mm	AER150-029-030
	70°	gelb / yellow	302 mm	AER150-029-070
	0°	grün / green	302 mm	AER150-027-000
			187,5 mm	AER140-027-000
	30°	rot / red	302 mm	AER150-027-030
			187,5 mm	AER140-027-030
	70°	gelb / yellow	302 mm	AER150-027-070
			187,5 mm	AER140-027-070

Endoskope, halbstarr

Endoscopes, semi-rigid

2,0 mm







Durchmesser Diameter	Blickrichtung Direction of view	Kennfarbe Colour code	Nutzlänge Working length	Bestell-Nr. Ordering number
	0°	grün / green	187,5 mm	AES140-020-000
	30°	rot / red	187,5 mm	AES140-020-030



Uretero-Renoskope, halbstarr
Uretero-Renoscopes, semi-rigid

6,0 – 7,5 Charr. / Fr.



Durchmesser * / Einblick Diameter * / Insight	Blickrichtung Direction of view	Kennfarbe Colour code	Instr.-Kanal Instr. channel	Nutzlänge Working length	Bestell-Nr. Ordering number
			Durchlaß / Charr. Capacity / Fr.		
seitlich versetzter Einblick / laterally offset eyepiece  	8°	schwarz / black	1 x 5 / 2 x 3	425 mm	AES150-075-008
				310 mm	AES140-075-008
seitlich versetzter Einblick / laterally offset eyepiece  	8°	schwarz / black	1 x 4 / 2 x 2,4	425 mm	AES130-060-008
				310 mm	AES120-060-008

* 7,5 Charr. / Fr. → Querschnitt / ross-section distal 10 Charr. / Fr.

* 6,0 Charr. / Fr. → Querschnitt / Cross-section distal 8 Charr. / Fr.

Weitere Modelle auf Anfrage. / Further models upon request.



Endoskope



Endoscopes

A-line
endoscopy

Uretero-Renoskope, HD, halbstarr
Uretero-Renoscopes, HD, semi-rigid

6,0 – 12 Charr. / Fr.

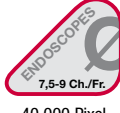



Durchmesser / Einblick Diameter / Insight	Blickrichtung Direction of view	Kennfarbe Colour code	Instr.-Kanal Instr. channel	Nutzlänge Working length	Bestell-Nr. Ordering number
			Durchlaß / Charr. Capacity / Fr.		
seitlicher Einblick / oblique eyepiece   40 000 Pixel	0° - 12°	weiß / white	6,8 1 x 5 / 2 x 3	150 mm	AES302-040-000
				310 mm	AES304-040-000
				425 mm	AES306-040-000
seitlicher Einblick / oblique eyepiece   17 000 Pixel	0° - 12°	weiß / white	5,1 1 x 4 / 2 x 2,4	140 mm	AES202-030-000
				310 mm	AES204-030-000
				425 mm	AES206-030-000



Perkutane Nephroskope, starr
Percutaneous Nephroscopes, rigid

24 – 26 Charr. / Fr.



Durchmesser * / Einblick Diameter * / Insight	Blickrichtung Direction of view	Kennfarbe Colour code	Instr.-Kanal Instr. channel	Nutzlänge Working length	Bestell-Nr. Ordering number
			Durchlaß / mm Capacity / mm		
	0°	grün / green	Ø 4,9	200 mm	AER520-074-000
				250 mm	AER530-074-000
	0°	grün / green	Ø 4,9	200 mm	AER525-074-000
				250 mm	AER535-074-000

* Quick-Lock System und weitere Modelle auf Anfrage. / Quick-Lock System and further models upon request.



...we can do it!



Kaltlichtkabel, HTT

Cold light cables, HTT



Durchmesser Diameter	Nutzlänge Working length	Bestell-Nr. Ordering number
3,5 mm	1 800 mm	92-951-035HTT
	2 300 mm	92-952-035HTT
	3 000 mm	92-953-035HTT
4,8 mm	1 800 mm	92-951-048HTT
	2 300 mm	92-952-048HTT
	3 000 mm	92-953-048HTT

HTT: High Transmission Technology
 Verschmolzene Glasfasern / Fused optical fibreglass

Merkmale / Features

- ▲ **Optische Qualitätsglasfasern**
 High-end optical fibreglass
- ▲ **Hohe Lichttransmission und Temperaturbeständigkeit (20 % mehr Lichttransmission gegenüber Standard-Lichtleitkabeln)**
 High light transmission and temperature-resistance (20 % more light transmission compared to standard light guide cables)
- ▲ **Zugentlastung und innenliegender Knickschutz für eine lange Lebensdauer**
 Stress relief and inner bending protection for a long life span
- ▲ **Hohe Flexibilität**
 High flexibility
- ▲ **Austauschbares Adaptersystem ohne Lichtverluste**
 Exchangeable adaptor system without light losses
- ▲ **Anwendbar für alle marktüblichen Kaltlichtquellen und Endoskope**
 Applicable to all brands of light sources and endoscopes
- ▲ **Autoklavierbar**
 Autoclavable



Adapter für Kaltlichtkabel

Adaptors for Cold Light Cables



Adapter → Lichtquelle Adaptor → Light source	Anschluss Connection	Bestell-Nr. Ordering number
	ACMI / Britisch Standard / Codman Welch Allyn / Stryker	92-960-002
	Allgaier / Storz / Rudolf / Aesculap	92-960-004
	Winter & Ibe	92-960-006
	Wolf / HSW / Dyonics / Sopro-Comeg / Medicon	92-960-008
	Heine	92-960-010
	Schott / Zeiss	92-960-012
	Olympus	92-960-014
	Volpi	92-960-018
	Fuji	92-960-022
	Pentax	92-960-024

Adapter → Endoskop Adaptor → Endoscope	Anschluss Connection	Bestell-Nr. Ordering number
	ACMI / Britisch Standard / Codman / ID=7,7 mm	92-962-002
	Allgaier / Rudolf / Storz / Olympus / Winter & Ibe / Aesculap	92-962-004
	Wolf / HSW / Dyonics / ID=9,0 mm	92-962-008
	Stryker	92-962-020

Notizen

Notes

Cysto-Urethroscopie

Cysto-Urethroscopy

A-line
endoscopy



UROLOGY









...we can do it!



Cysto-Urethroskop-Sets
Cysto-Urethroscope sets

17 – 25 Charr. / Fr.

Endoskop / Endoscope				
				
Durchmesser Diameter	Blickrichtung Direction of view	Kennfarbe Colour code	Nutzlänge Working length	Bestell-Nr. Ordering number
	0°	grün / green	302 mm	AER300-040-000
	12°	schwarz / black	302 mm	AER300-040-012
	30°	rot / red	302 mm	AER300-040-030
	70°	gelb / yellow	302 mm	AER300-040-070
Schaft mit 2 starren Hähnen inkl. Standardobturator / Sheath with 2 fixed stopcocks incl. Standard Obturator *				
				
Charr. Fr.	Kennfarbe Colour code	Durchlass Charr. / Capacity Fr.		Bestell-Nr. Ordering number
		Endoskopbrücken Endoscope Bridges	Albarran-Lenkhebel Albarran Deflector	
17	gelb / yellow	1 x 5 / 2 x 4	1 x 5 / 2 x 4	ACU010-017-302
19	grün / green	1 x 6 / 2 x 5	1 x 6 / 2 x 5	ACU010-019-302
21	rot / red	1 x 8 / 2 x 6	1 x 7 / 2 x 5	ACU010-021-302
23	blau / blue	1 x 10 / 2 x 7	1 x 9 / 2 x 6	ACU010-023-302
25	weiß / white	1 x 12 / 2 x 8	1 x 12 / 2 x 8	ACU010-025-302
Endoskopbrücken / Endoscope Bridges				
				
Diagnose Diagnostic		1 Instrumenten-Kanal 1 Instrument channel		2 Instrumenten-Kanäle 2 Instrument channels
ACU100-040-302		ACU102-040-302		ACU104-040-302
Arbeitseinsatz mit Albarran-Lenkhebel / Working element with Albarran Deflector				
				
1 Instrumenten-Kanal / 1 Instrument channel				ACU120-040-302
2 Instrumenten-Kanäle / 2 Instrument channels				ACU124-040-302

* Weitere Schaftmodelle auf Anfrage. / Further sheath models upon request.



Cysto-Urethroskopie

Cysto-Urethroscopy

A-line
endoscopy



Obturatoren für Cysto-Urethroskopschäfte

Obturator for Cysto-Urethroscope sheaths

17 – 25 Charr. / Fr.

Standardobturator / Standard Obturator		
Charr. Fr.	Kennfarbe Colour code	Bestell-Nr. Ordering number
17	gelb / yellow	ALU080-017-302
19	grün / green	ALU080-019-302
21	rot / red	ALU080-021-302
23	blau / blue	ALU080-023-302
25	weiß / white	ALU080-025-302
Sichtobturator / Viewing Obturator		
Charr. Fr.	Kennfarbe Colour code	Bestell-Nr. Ordering number
17	gelb / yellow	ACU084-017-302
19	grün / green	ACU084-019-302
21	rot / red	ACU084-021-302
23	blau / blue	ACU084-023-302
25	weiß / white	ACU084-025-302



...we can do it!



Optische Instrumente für Cysto-Urethroskopschäfte
Optical Instruments for Cysto-Urethroscope sheaths

19 – 25 Charr. / Fr.



<p>Probeexzisionszange, doppelbeweglich, für Endoskope 0° / 12° / (30°) Biopsy forceps, double action, for endoscopes 0° / 12° / (30°)</p>	<p>Probeexzisionszange, doppelbeweglich, für Endoskope 12° / 30° Biopsy forceps, double action, for endoscopes 12° / 30°</p>
ACU152-040-302	ACU154-040-302
<p>Fasszange, doppelbeweglich, für Endoskope 0° / 12° / (30°) Grasping forceps, double action, for endoscopes 0° / 12° / (30°)</p>	<p>Probeexzisionszange, doppelbeweglich, für Endoskop 70° Biopsy forceps, double action, for endoscope 70°</p>
ACU170-040-302	ACU156-040-302
<p>Probeexzisionszange, doppelbeweglich, durchschneidend, für Endoskope 0°/12°/(30°) Biopsy forceps, double action, through cutting, for endoscopes 0° / 12° / (30°)</p>	<p>Schere, doppelbeweglich, für Endoskope 0° / 12° / (30°) Scissors, double action, for endoscopes 0° / 12° / (30°)</p>
ACU160-040-302	ACU180-040-302
<p>Adapter für optische Instrumente zur Verwendung mit Resektoskop-Schäften (24 – 27 Charr.) Adaptor for optical instruments to be used with Resectoscope Sheaths (24 – 27 Fr.)</p>	
ACU150-040-302	

Weitere Modelle auf Anfrage. / Further models upon request.



Cysto-Urethroskopie

Cysto-Urethroscopy

A-line
endoscopy

Optische Steinzange für Cysto-Urethroskopschäfte
Optical Stone Forceps for Cysto-Urethroscope sheaths

25 Charr. / Fr.

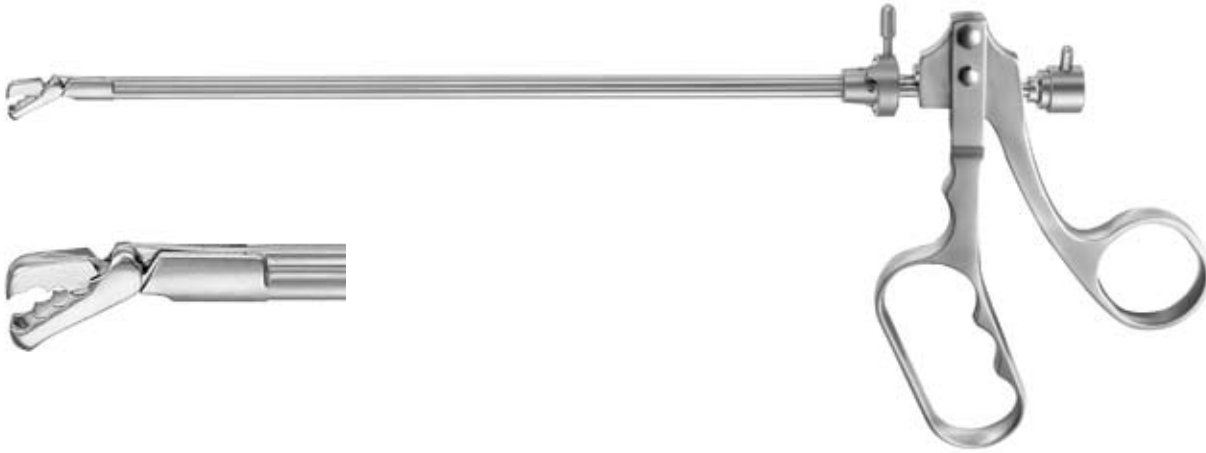

	Bestell-Nr. Ordering number
Steinzange für Endoskope, 0°, 12°, 30° <i>Stone crushing forceps for endoscopes, 0°, 12°, 30°</i>	ACU202-040-302



	Bestell-Nr. Ordering number
Adapter für den Einsatz mit Resektoskopschäften 26 – 28,5 Charr. (nur verwendbar mit Außenschäft) <i>Adaptor for use with resectoscope sheaths 26 – 28.5 Fr. (to be used with outer sheath only)</i>	ACU200-040-302







...we can do it!

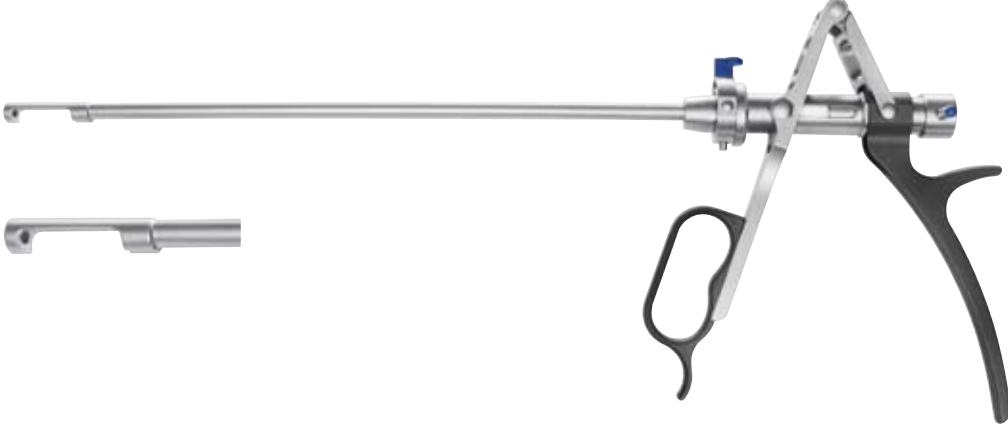

Optisches Steinzangen-Set
Optical Stone Crushing Forceps set



		Bestell-Nr. Ordering number
Arbeitselement / Optische Steinzange für Endoskope, 12°, 30° Working element / Stone Crushing Forceps for endoscopes, 12°, 30°		ACU230-040-302
Schaft mit Zentralhahn, für optische Steinzange / Sheath with central valve, for optical stone crushing forceps		
		
24 Charr. / Fr.	blau / blue	ACU214-024-302
Schaft mit 2 starren Hähnen, für optische Steinzange / Sheath with 2 fixed stopcocks, for optical stone crushing forceps		
		
24 Charr. / Fr.	blau / blue	ACU210-024-302
Standardobturator / Standard Obturator		
		
24 Charr. / Fr.	blau / blue	ACU220-024-302
Schafteinsatz mit 7 Charr. Instrumentenkanal / Sheath insert with 7 Fr. instrument channel		
		
24 Charr. / Fr.	blau / blue	ACU226-024-302



Cysto-Urethroskopie





Cysto-Urethroscopy

A-line
endoscopy

Cysto-Urethroskop-Set

Cysto-Urethroscope set

15 Charr. / Fr.

Endoskope / Endoscopes				
				
Durchmesser Diameter	Blickrichtung Direction of view	Kennfarbe Colour code	Nutzlänge Working length	Bestell-Nr. Ordering number
	0°	grün / green	302 mm	AER150-029-000
	30°	rot / red	302 mm	AER150-029-030
	70°	gelb / yellow	302 mm	AER150-029-070
	0°	grün / green	302 mm	AER150-027-000
	30°	rot / red	302 mm	AER150-027-030
	70°	gelb / yellow	302 mm	AER150-027-070
Schaft mit 2 starren Hähnen inkl. Standardobturator / Sheath with 2 fixed stopcocks incl. Standard Obturator				
				
Charr. Fr.	Kennfarbe Colour code	Durchlass Charr. Capacity Fr.	Bestell-Nr. Ordering number	
15	schwarz / black	1 x 5	ACU011-015-302	
Standardobturator / Standard Obturator				
				
15	schwarz / black		ACU081-015-302	









...we can do it!



Cysto-Urethroskop-Sets
Cysto-Urethroscope sets

15 Charr. / Fr.

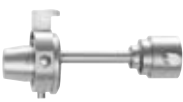
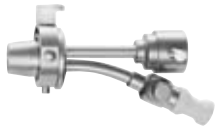
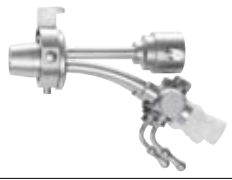

Endoskope / Endoscopes				
				
Durchmesser Diameter	Blickrichtung Direction of view	Kennfarbe Colour code	Nutzlänge Working length	Bestell-Nr. Ordering number
	0°	grün / green	302 mm	AER150-029-000
	30°	rot / red	302 mm	AER150-029-030
	70°	gelb / yellow	302 mm	AER150-029-070
	0°	grün / green	302 mm	AER150-027-000
	30°	rot / red	302 mm	AER150-027-030
	70°	gelb / yellow	302 mm	AER150-027-070
Schaft mit 2 starren Hähnen inkl. Standardobturator / Sheath with 2 fixed stopcocks incl. Standard Obturator *				
				
Charr. Fr.	Kennfarbe Colour code	Durchlass Charr. / Capacity Fr.		Bestell-Nr. Ordering number
		Endoskopbrücken Endoscope Bridges	Albarran-Lenkhebel Albarran Deflector	
15	weiss / white	1 x 5 / 2 x 3	1 x 5 / 2 x 3	ACU010-015-302
Endoskopbrücken / Endoscope Bridges				
				
Diagnose Diagnostic		1 Instrumenten-Kanal 1 Instrument channel		2 Instrumenten-Kanäle 2 Instrument channels
ACU100-029-302		ACU102-029-302		ACU104-029-302
Arbeitseinsatz mit Albarran-Lenkhebel / Working element with Albarran Deflector				
				
1 Instrumenten-Kanal / 1 Instrument channel				ACU120-029-302
2 Instrumenten-Kanäle / 2 Instrument channels				ACU124-029-302

* Weitere Schaftmodelle auf Anfrage. / Further sheath models upon request.



Cysto-Urethroskopie

Cysto-Urethroscopy

A-line
endoscopy

Obturator für Cysto-Urethroskopschaft
Obturator for Cysto-Urethroscope sheath

15 Charr. / Fr.



Standardobturator / Standard Obturator





Charr. Fr.	Kennfarbe Colour code	Bestell-Nr. Ordering number
15	weiß / white	ACU080-015-302



...we can do it!



Cysto-Urethroskop-Adapter und Gummikappe
Cysto-Urethroscope-Adaptor and Rubber Cap

Cysto-Urethroskop-Adapter / Cysto-Urethroscope-Adaptor	
	
	Bestell-Nr. Ordering number
für die Cysto-Urethroskopie bei Frauen for female Cysto-Urethroscopy	ACU800-000-000
Gummikappe / Rubber Cap	
	
	Bestell-Nr. Ordering number
für Instrumentenkanal for instrument channel	AEA010-010-000



Cysto-Urethroskopie

Cysto-Urethroscopy

Zangen, flexibel, isoliert und halbstarr

Forceps, flexible, insulated and semi-rigid

Nutzlänge 400 mm Working length 400 mm	Durchmesser / Diameter		flexibel flexible	flexibel isoliert flexible insulated	halbstarr semi-rigid
	mm	Charr. / Fr.			
Fremdkörperzange, Alligatormaul, doppelbeweglich / Foreign body forceps, alligator jaw, double action					
	1,0	3	AFF204-210-040		AFF204-610-040
	1,6	5	AFF204-216-040	AFF204-416-040	AFF204-616-040
	2,3	7	AFF204-223-040	AFF204-423-040	AFF204-623-040
	3,0	9	AFF204-230-040	AFF204-430-040	AFF204-630-040
Probeexzisions- und Fasszange, oval, gezahnt, doppelbeweglich / Biopsy and grasping forceps, oval, serrated, double action					
	1,6	5	AFF203-216-040	AFF203-416-040	AFF203-616-040
	2,1	6	AFF203-221-040	AFF203-421-040	AFF203-621-040
	2,3	7	AFF203-223-040	AFF203-423-040	AFF203-623-040
	3,0	9	AFF203-230-040	AFF203-430-040	AFF203-630-040
Fasszange für Steinstrasse, doppelbeweglich / Grasping forceps for large stone fragments, double action					
	1,6	5	AFF208-216-040	AFF208-416-040	AFF208-616-040
Probeexzisionszange, oval, doppelbeweglich / Biopsy forceps, oval, double action					
	1,0	3	AFF200-210-040		AFF200-610-040
	1,6	5	AFF200-216-040	AFF200-416-040	AFF200-616-040
	2,1	6	AFF200-221-040	AFF200-421-040	AFF200-621-040
	2,3	7	AFF200-223-040	AFF200-423-040	AFF200-623-040
	3,0	9	AFF200-230-040	AFF200-430-040	AFF200-630-040

Weitere Modelle auf Anfrage. / Further models upon request.



Zangen, flexibel, isoliert und halbstarr
Forceps, flexible, insulated and semi-rigid

Nutzlänge 400 mm Working length 400 mm	Durchmesser / Diameter		flexibel flexible	flexibel isoliert flexible insulated	halbstarr semi-rigid
	mm	Charr. / Fr.			
Schere, einfachbeweglich / Scissors, single action					
	1,6	5	AFF201-216-040	AFF201-416-040	AFF201-616-040
	2,1	6	AFF201-221-040	AFF201-421-040	AFF201-621-040
	2,3	7	AFF201-223-040	AFF201-423-040	AFF201-623-040
	3,0	9	AFF201-230-040	AFF201-430-040	AFF201-630-040
Hakenschere, einfachbeweglich / Hook Scissors, single action					
	2,3	7	AFF202-223-040	AFF202-423-040	AFF202-623-040
	3,0	9	AFF202-230-040	AFF202-430-040	AFF202-630-040
Schere, doppelbeweglich / Scissors, double action					
	2,3	7	AFF205-223-040	AFF205-423-040	AFF205-623-040

Weitere Modelle auf Anfrage. / Further models upon request.



Cysto-Urethroskopie

Cysto-Urethroscopy

Flexible Steinfänger und Diathermie-Schlingen

Flexible Stone Extractors and Diathermy Loops

	Durchmesser / Diameter		Drähte wires	Nutzlänge Working length	Bestell-Nr. Ordering number
	mm	Charr. / Fr.			
Steinfänger / Stone Extractor					
	0,8	2,5	4	400 mm	AFI210-208-040
	1,0	3	4	400 mm	AFI210-210-040
	1,6	5	4	400 mm	AFI210-216-040
			5	400 mm	AFI210-416-040
			6	400 mm	AFI210-616-040
	2,3	7	4	400 mm	AFI210-223-040
			5	400 mm	AFI210-423-040
			6	400 mm	AFI210-623-040
Griff alleine für Steinfänger / Handle only for Stone Extractor					
	0,8	2,5	4	400 mm	AFI210-016-000
	1,0	3	4	400 mm	
	1,6	5	4 – 6	400 mm	
	2,3	7	4 – 6	400 mm	AFI210-023-000
Diathermieschlinge / Diathermy Loop					
	1,6	5	–	500 mm	AHI110-416-050
	2,3	7	–	500 mm	AHI110-423-050
Griff alleine, mit HF-Anschluss für Diathermieschlinge / Handle only, with HF-Connection for Diathermy Loop					
	1,6	5	–	500 mm	AHI110-000-000
	2,3	7	–	500 mm	

Weitere Modelle auf Anfrage. / Further models upon request.



Flexible Elektroden, monopolar
Flexible Electrodes, monopolar

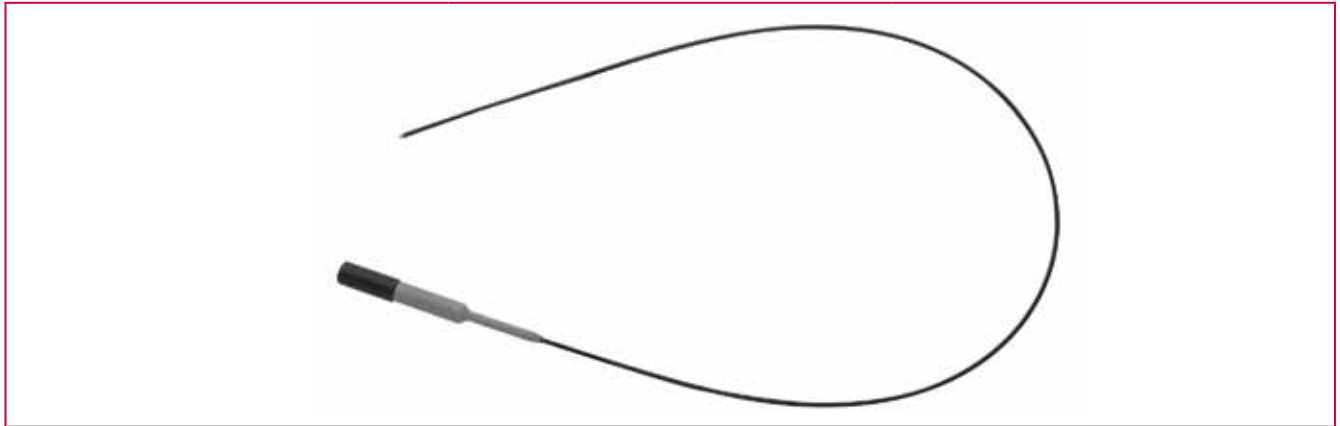

Nadelelektrode / Needle Electrode



Durchmesser / Diameter		Nutzlänge / Working length	Bestell-Nr. / Ordering number
mm	Charr. / Fr.		
1,0	3	450 mm	AHI010-410-045
1,6	5	450 mm	AHI010-416-045
2,3	7	450 mm	AHI010-423-045

Knopfelektrode / Button Electrode



1,0	3	450 mm	AHI020-410-045
1,3	4	450 mm	AHI020-413-045
1,6	5	450 mm	AHI020-416-045
2,3	7	450 mm	AHI020-423-045
2,6	8	450 mm	AHI020-426-045
3,0	9	450 mm	AHI020-430-045
3,3	10	450 mm	AHI020-433-045

Schlingenelektrode / Loop Electrode



1,6	5	450 mm	AHI030-416-045
2,3	7	450 mm	AHI030-423-045
3,0	9	450 mm	AHI030-430-045

Weitere Nutzlängen auf Anfrage. / Further working lengths upon request.



Cysto-Urethroskopie

Cysto-Urethroscopy

Hochfrequenz-Kabel, monopolar

High-Frequency Cables, monopolar



instrumentenseitig instrument side	geräteseitig equipment side	Durchmesser Diameter	Länge Length	Bestell-Nr. Ordering number
		4 mm	3 m	AHC010-040-300
	Für Geräte von Berchtold, Martin, Aesculap For Berchtold, Martin, Aesculap units			
		4 mm	3 m	AHC012-040-300
	Für Geräte von Berchtold, Martin, Erbe T-Serie For Berchtold, Martin, Erbe T-Series units			
		5 mm	3 m	AHC014-050-300
	Für Geräte von Erbe ACC/ICC, Storz For Erbe ACC/ICC, Storz units			
	8 mm	3 m	AHC016-080-300	
Für Geräte von Valleylab, Bovie, Conmed For Valleylab, Bovie, Conmed units				

Weitere Kabel auf Anfrage. / Further cables upon request.



Basis-Set für Cysto-Urethroskopie
Basic set for Cysto-Urethroscopy

21 Charr. / Fr.



Artikelbezeichnung Article description	Produkt Product	Bestell-Nr. Ordering number
Komplett-Set Complete Set		ASE280-020-010
Endoskop 4,0 mm / 30°, 302 mm Endoscope 4,0 mm / 30°, 302 mm		AER300-040-030
Cysto-Urethroskopschaft inkl. Standardobturator, 2 starre Hähne, 21 Charr. Cysto-Urethroscopy sheath incl. standard obturator, 2 fixed stopcocks, 21 Fr.		ACU010-021-302
Sichtobturator, 21 Charr. Viewing Obturator, 21 Fr.		ACU084-021-302
Endoskopbrücke mit 1 Instrumentenkanal Endoscope Bridge with 1 instrument channel		ACU102-040-302
Arbeitseinsatz mit Albarran-Hebel, 2 Instrumentenkanäle Working element with Albarran deflector, 2 instrument channels		ACU124-040-302
Flexible Fremdkörperzange, Alligatormaul, 400 mm, 5 Charr. Flexible foreign body forceps, Alligator jaw, 400 mm, 5 Fr.		AFF204-216-040
Flexible Probeexcisionszange, 400 mm, 7 Charr. Flexible biopsy forceps, 400 mm, 7 Fr.		AFF200-223-040
Flexible Schere, 400 mm, 5 Charr. Flexible scissors, 400 mm, 5 Fr.		AFF201-216-040
Flexibler Steinfänger komplett mit Griff, 400 mm, 5 Charr. Flexible stone extractor complete with handle, 400 mm, 5 Fr.		AFI210-016-000 AFI210-216-040
Flexible Knopfelektrode, 450 mm, 5 Charr. Flexible button electrode, 450 mm, 5 Fr.		AHI020-416-045
HF-Kabel, monopolar, für ERBE ACC/ICC, STORZ-Geräte HF Cable, monopolar, for ERBE ACC/ICC, STORZ units		AHC014-050-300
Urethrotom nach OTIS für Erwachsene (klassisch) Urethrotome by OTIS for adults (classical)		60-782-000
Blasenspritze, 150 ml Bladder syringe, 150 ml		418-928-150

Notizen

Notes

Resektoskopie

Resectoscopy

A-line
endoscopy



UROLOGY









...we can do it!



Resektoskop-Sets mit intermittierender Spülung
Resectoscope sets with intermittent irrigation

24 – 27 Charr. / Fr.

Endoskop / Endoscope				
				
Durchmesser Diameter	Blickrichtung Direction of view	Kennfarbe Colour code	Arbeitslänge Working length	Bestell-Nr. Ordering number
	30°	rot / red	302 mm	AER300-040-030
Resektoskopschaft mit starren Hähnen / Resectoscope sheath with fixed stopcocks				
				
	24 Charr. / Fr.		gelb / yellow	ARS010-024-302
	27 Charr. / Fr.		schwarz / black	ARS010-027-302
Standardobturator / Standard Obturator				
				
	24 Charr. / Fr.		gelb / yellow	ARS080-024-302
	27 Charr. / Fr.		schwarz / black	ARS080-027-302
Arbeitselement, passiv schneidend <i>Working Element, passive cutting action</i>		Schlingenelektrode, abgewinkelt, 30° rückwärts <i>Loop electrode, angled, 30° backwards</i>		
				
ARS100-040-302		24 Charr. / Fr.		
		gelb / yellow		
ARS100-040-302		ARS150-024-302		



Resektoskopie











Resectoscopy

A-line
endoscopy

Resektoskop-Sets mit Dauerspül-Doppelschaft-System, feststehend
Resectoscope sets with continuous flow double-sheath system, fixed

26 – 28,5 Charr. / Fr.













Endoskop / Endoscope								
								
Durchmesser Diameter	Blickrichtung Direction of view	Kennfarbe Colour code	Nutzlänge Working length	Bestell-Nr. Ordering number				
	30°	rot / red	302 mm	AER300-040-030				
Innenschaft / Inner sheath (QUICK LOCK)		Standardobturatoren / Standard Obturators						
								
24 Charr. / Fr.		ARS020-024-302		ARS080-024-302				
27 Charr. / Fr.		ARS020-027-302		ARS080-027-302				
Außenschaft mit 2 starren Hähnen / Outer sheath with 2 fixed stopcocks (QUICK LOCK)								
								
Perforation Perforation	 rundum surrounding		 nur oben/unten top/bottom only		 rundum gefenstert surrounding slits		 nur oben gefenstert slits on top only	
26 Charr. / Fr.	28,5 Charr. / Fr.		26 Charr. / Fr.		26 Charr. / Fr.		26 Charr. / Fr.	
gelb / yellow	schwarz / black		gelb / yellow		gelb / yellow		gelb / yellow	
ARS030-026-302	ARS030-028-302		ARS032-026-302		ARS034-026-302		ARS036-026-302	
Arbeitselement, passiv schneidend Working Element, passive cutting action				Schlingenelektrode, abgewinkelt, 30° rückwärts Loop electrode, angled, 30° backwards				
								
				24 Charr. / Fr.				
				gelb / yellow				
ARS100-040-302				ARS150-024-302				



Resektoskop-Sets mit Dauerspül-Doppelschaft-System, drehbar
Resectoscope sets with continuous flow double-sheath system, rotatable

26 – 28,5 Charr. / Fr.



Endoskop / Endoscope								
								
Durchmesser Diameter	Blickrichtung Direction of view	Kennfarbe Colour code	Nutzlänge Working length	Bestell-Nr. Ordering number				
	30°	rot / red	302 mm	AER300-040-030				
Innenschaft / Inner sheath (QUICK LOCK)			Standardobturator / Standard Obturator					
								
24 Charr. / Fr.		ARS050-024-302	ARS080-024-302					
27 Charr. / Fr.		ARS050-027-302	ARS080-027-302					
Außenschaft mit 2 starren Hähnen / Outer sheath with 2 fixed stopcocks (QUICK LOCK)								
								
Perforation Perforation	 rundum surrounding		 nur oben/unten top/bottom only		 rundum gefenstert surrounding slits		 nur oben gefenstert slits on top only	
	26 Charr. / Fr.	28,5 Charr. / Fr.	26 Charr. / Fr.	26 Charr. / Fr.	26 Charr. / Fr.	26 Charr. / Fr.	26 Charr. / Fr.	
gelb / yellow	schwarz / black	gelb / yellow	gelb / yellow	gelb / yellow	gelb / yellow	gelb / yellow	gelb / yellow	
ARS060-026-302	ARS060-028-302	ARS062-026-302	ARS064-026-302	ARS066-026-302	ARS066-026-302	ARS066-026-302	ARS066-026-302	
Arbeitselement, passiv schneidend Working Element, passive cutting action				Schlingenelektrode, abgewinkelt, 30° rückwärts Loop electrode, angled, 30° backwards				
								
				24 Charr. / Fr.				
				gelb / yellow				
ARS100-040-302				ARS150-024-302				







Obturatoren für Resektoskopschäfte

Obturator for Resectoscope sheaths

24 – 28,5 Charr. / Fr.



Charr Fr.	Kennfarbe Colour code	Instr.-Kanal Instr. channel	Bestell.-Nr. Ordering number
		Durchlaß / Charr. Capacity / Fr.	
Standardobturator / Standard Obturator			
			
24	yellow / gelb		ARS080-024-302
27	schwarz / black		ARS080-027-302
Beweglicher Obturator / Deflecting Obturator			
			
24	yellow / gelb		ARS082-024-302
27	schwarz / black		ARS082-027-302
Sichtobturator / Viewing Obturator			
			
24	yellow / gelb		ARS084-024-302
27	schwarz / black		ARS084-027-302
Sichtobturator mit Instrumentenkanal / Viewing Obturator with instrument channel			
			
24	yellow / gelb	5	ARS086-024-302
27	schwarz / black	7	ARS086-027-302



...we can do it!



Arbeitselemente für Resektoskope
Working Elements for Resectoscopes

24 – 28,5 Charr. / Fr.



Arbeitselemente, passiv schneidend / Working Elements, passive cutting action



Schnitt erfolgt durch Federdruck / Spring-assisted cutting action



geschlossener Griff / closed handle

ARS100-040-302



offener Griff / open handle

ARS102-040-302

Arbeitselemente, aktiv schneidend / Working Elements, active cutting action



Schnitt erfolgt gegen Federdruck / Manual cutting action and spring-assisted release



geschlossener Griff / closed handle

ARS110-040-302



offener Griff / open handle

ARS112-040-302

















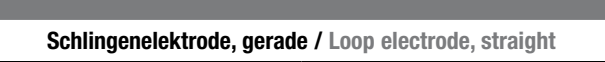









Elektroden für Resektoskope, monopolar

Electrodes for Resectoscopes, monopolar

24 – 28,5 Charr. / Fr.



			
Schlingenelektrode abgewinkelt, 30° rückwärts Loop electrode, angled, 30° backwards		Kugelelektrode / Rollerball electrode	
			
24 Charr. / Fr.		3 mm	5 mm
27 Charr. / Fr.		24 Charr. / Fr.	
ARS150-024-302		ARS150-027-302	
			
Schlingenelektrode, abgewinkelt / Loop electrode, angled		Rollenelektrode, glatt / Roller electrode, smooth	
			
24 Charr. / Fr.		3 mm	5 mm
27 Charr. / Fr.		24 Charr. / Fr.	
ARS152-024-302		ARS152-027-302	
			
Schlingenelektrode, gerade / Loop electrode, straight		Vaporisationselektrode, glatt / Vaporization electrode, smooth	
			
24 Charr. / Fr.		3 mm	5 mm
27 Charr. / Fr.		24 Charr. / Fr.	
ARS154-024-302		ARS154-027-302	
			
Messerelektrode, abgewinkelt / Knife electrode, angled		Kegelelektrode, abgewinkelt / Conical electrode, angled	
			
24 Charr. / Fr.		24 Charr. / Fr.	
ARS160-024-302		ARS170-024-302	
			
Bandelektrode, abgewinkelt / Band electrode, angled		Bandelektrode, abgewinkelt, 30° rückwärts Band electrode, angled, 30° backwards	
			
24 Charr. / Fr.		24 Charr. / Fr.	27 Charr. / Fr. *
27 Charr. / Fr. *		27 Charr. / Fr. *	
ARS202-024-302		ARS202-027-302	
			
Kürette, scharf (nicht zur Verwendung mit HF-Strom) Curette, sharp (not for use with HF current)		Schutzhülse, rostfreier Stahl Protecting Sleeve, stainless steel	
			
24 Charr. / Fr.		für die Sterilisation und Aufbewahrung / for sterilization and storage	
27 Charr. / Fr.		AEA030-000-000	
ARS220-024-302		ARS220-027-302	

24 Charr. / Fr. = Kennfarbe gelb / Colour code yellow







27 Charr. / Fr. = Kennfarbe braun / Colour code brown

* Auf Anfrage. / Upon request.



Kleinkalibriges Resektoskop-Set mit intermittierender Spülung
Slim calibre Resectoscope set with intermittent irrigation

19 Charr. / Fr.

Endoskop / Endoscope				
				
Durchmesser Diameter	Blickrichtung Direction of view	Kennfarbe Colour code	Nutzlänge Working length	Bestell-Nr. Ordering number
	30°	rot / red	302 mm	AER150-029-030
Resektoskopschaft mit starrem Hahn / Resectoscope sheath with fixed stopcock				
				
19 Charr. / Fr.		weiß / white		ARS010-019-302
Standardobturator / Standard Obturator				
				
19 Charr. / Fr.		weiß / white		ARS080-019-302
Arbeitselement, passiv schneidend Working Element, passive cutting action			Schlingenelektrode, abgewinkelt, 30° rückwärts Loop electrode, angled, 30° backwards	
				
ARS100-029-302			19 Charr. / Fr.	
			weiß / white	
ARS100-029-302			ARS150-019-302	

Auch passend für 2,7 mm Endoskope. / Also suitable for 2,7 mm Endoscopes.



Resektoskopie









Resectoscopy

A-line
endoscopy

Kleinkalibriges Resektoskop-Set mit Dauerspül-Doppelschaft-System, drehbar
Slim calibre Resectoscope set with continuous flow double-sheath system, rotatable

22 Charr. / Fr.



Endoskope / Endoscopes				
				
Durchmesser Diameter	Blickrichtung Direction of view	Kennfarbe Colour code	Nutzlänge Working length	Bestell-Nr. Ordering number
	30°	rot / red	302 mm	AER150-029-030
Innenschaft / Inner Sheath (QUICK LOCK)			Standardobturator / Standard Obturator	
				
19 Charr. / Fr. ARS050-019-302			19 Charr. / Fr. ARS080-019-302	
Außenschaft mit 2 starren Hähnen / Outer sheath with 2 fixed stopcocks (QUICK LOCK)			weiß / white	
				
Perforation Perforation				
	rundum surrounding			
22 Charr. / Fr. ARS060-022-302				
Arbeitselement, passiv schneidend Working Element, passive cutting action			Schlingenelektrode, abgewinkelt, 30° rückwärts Loop electrode, angled, 30° backwards	
				
ARS100-029-302			19 Charr. / Fr. weiß / white	
			ARS150-019-302	



Auch passend für 2,7 mm Endoskope. / Also suitable for 2,7 mm Endoscopes.



Obturatoren für kleinkalibrige Resektoskopschäfte
Obturator for slim calibre Resectoscope sheaths

19 – 22 Charr. / Fr.



Charr. Fr.	Kennfarbe Colour code	Instr.-Kanal Instr. channel	Bestell-Nr. Ordering number
		Durchlass / Charr. Capacity / Fr.	
Standardobturator / Standard Obturator			
			
19	weiß / white		ARS080-019-302
Sichtobturator / Viewing Obturator			
			
19	weiß / white		ARS084-019-302



Arbeitselemente für kleinkalibrige Resektoskope

Working Elements for slim calibre Resectoscopes

19 – 22 Charr. / Fr.



Arbeitselemente, passiv schneidend / Working Elements, passive cutting action



Schnitt erfolgt durch Federdruck / Spring-assisted cutting action



geschlossener Griff / closed handle

ARS100-029-302



offener Griff / open handle

ARS102-029-302

Arbeitselemente, aktiv schneidend / Working Elements, active cutting action



Schnitt erfolgt gegen Federdruck / Manual cutting action and spring-assisted release



geschlossener Griff / closed handle

ARS110-029-302



offener Griff / open handle

ARS112-029-302



Elektroden für kleinkalibrige Resektoskope, monopolar
Electrodes for slim calibre Resectoscopes, monopolar

19 – 22 Charr. / Fr.



Schlingenelektrode, abgewinkelt, 30° rückwärts <i>Loop electrode, angled, 30° backwards</i>	Kugelelektrode, 3 mm / Rollerball electrode, 3 mm
19 Charr. / Fr. ARS150-019-302	19 Charr. / Fr. ARS180-019-302
Schlingenelektrode, gerade / Loop electrode, straight	Rollenelektrode, glatt, 3 mm / Roller electrode, smooth, 3 mm
19 Charr. / Fr. ARS154-019-302	19 Charr. / Fr. ARS184-019-302
Messerelektrode, abgewinkelt / Knife electrode, angled	Schutzhülse, rostfreier Stahl / Protecting Sleeve, stainless steel
19 Charr. / Fr. ARS160-019-302	für die Sterilisation und Aufbewahrung / for sterilization and storage AEA030-000-000

19 Charr. / Fr. = Kennfarbe weiß / Colour code white



Hochfrequenz-Kabel, monopolar

High-Frequency Cables, monopolar

instrumentenseitig instrument side	geräteseitig equipment side	Durchmesser Diameter	Länge Length	Bestell-Nr. Ordering number
				
		4 mm	3 m	AHC010-040-300
	Für Geräte von Berchtold, Martin, Aesculap For Berchtold, Martin, Aesculap units			
		4 mm	3 m	AHC012-040-300
	Für Geräte von Berchtold, Martin, Erbe T-Serie For Berchtold, Martin, Erbe T-Series units			
		5 mm	3 m	AHC014-050-300
	Für Geräte von Erbe ACC/ICC, Storz For Erbe ACC/ICC, Storz units			
		8 mm	3 m	AHC016-080-300
	Für Geräte von Valleylab, Bovie, Conmed For Valleylab, Bovie, Conmed units			





Weitere Kabel auf Anfrage. / Further cables upon request.



...we can do it!



Evakuator und Blasenpritzen zur Adaption an Resektoskopschäfte
Evacuator and Bladder Syringes for adaption to Resectoscope sheaths

Evakuator / Evacuator	
	
	Bestell-Nr. Ordering number
komplett mit Schaftanschluß und Verriegelung complete with sheath connection and locking device	AEI100-000-000
Glasbehälter, alleine / Glass bulb, only	AEI104-000-000
Gummiball, alleine / Rubber bulb, only	AEI106-000-000
Schaftanschluß mit Verriegelung, alleine / Sheath connection with locking device, only	
	
Schaftanschluß mit Konus, alleine / Sheath connection with cone, only	
	
Blasenspritze mit Adapter / Bladder Syringe with adaptor	
	
50 ml	418-928-050
75 ml	418-928-075
100 ml	418-928-100
150 ml	418-928-150
200 ml	418-928-200



Resektoskopie

Resectoscopy

A-line
endoscopy

Basis-Set für Resektoskopie (TUR): Dauerspülsystem, passiv
Basic set for Resectoscopy (TUR): continuous irrigation system, passive

26 Charr. / Fr.

















Artikelbezeichnung Article description	Produkt Product	Bestell-Nr. Ordering number
Komplett-Set Complete Set		ASE280-030-020
Endoskop 4,0 mm / 30°, 302 mm Endoscope 4,0 mm / 30°, 302 mm		AER300-040-030
Dauerspül-Aussenschaft, drehbar, 26 Charr. Continuous flow outer sheath, rotatable, 26 Fr.		ARS060-026-302
Innenschaft, für Dauerspül-Aussenschaft 26 Charr., drehbar, 24 Charr. Inner sheath, for continuous flow outer sheath 26 Fr., rotatable, 24 Fr.		ARS050-024-302
Standardobturator, 24 Charr. Standard obturator, 24 Fr.		ARS080-024-302
Arbeitselement, passiv schneidend Working element, passive cutting action		ARS100-040-302
Schlingenelektrode, abgewinkelt, 30° rückwärts, 24 Charr. Cutting loop electrode, angled, 30° backwards, 24 Fr.		ARS150-024-302
Bandelektrode, abgewinkelt, 24 Charr. Band electrode, angled, 24 Fr.		ARS202-024-302
Rollenelektrode, Ø 3,0 mm, 24 Charr. Roller electrode, Ø 3.0 mm, 24 Fr.		ARS184-024-302
Messerelektrode, abgewinkelt, 24 Charr. Knife electrode, angled, 24 Fr.		ARS160-024-302
Schutzhülse für Elektroden, rostfreier Stahl Protecting sleeve for electrodes, stainless steel		AEA030-000-000
HF-Kabel, monopolar, für ERBE ACC/ICC, STORZ-Geräte HF cable, monopolar, for ERBE ACC/ICC, STORZ units		AHC014-050-300
Urethrotom nach OTIS für Erwachsene (klassisch) Urethrotome by OTIS for adults (classical)		60-782-000
Evakuator Evacuator		AEI100-000-000
Blasenspritze, 150 ml Bladder syringe, 150 ml		418-928-150



Basis-Set für Resektoskopie (TUR), kleinkalibrig:
Dauerspülsystem, passiv
Basic set for Resectoscopy (TUR), small calibre:
continuous irrigation system, passive

22 Charr. / Fr.



Artikelbezeichnung Article description	Produkt Product	Bestell-Nr. Ordering number
Komplett-Set Complete Set		ASE280-030-010
Endoskop 2,9 mm / 30°, 302 mm Endoscope 2,9 mm / 30°, 302 mm		AER150-029-030
Dauerspül-Aussenschaft, drehbar, 22 Charr. Continuous flow outer sheath, rotatable, 22 Fr.		ARS060-022-302
Innenschaft, 19 Charr., für Dauerspül-Aussenschaft, drehbar, 22 Charr. Inner sheath, 19 Fr., for continuous flow outer sheath, rotatable, 22 Fr.		ARS050-019-302
Standardobturator, 19 Charr. Standard obturator, 19 Fr.		ARS080-019-302
Arbeitselement, passiv schneidend Working element, passive cutting action		ARS100-029-302
Schlingenelektrode, abgewinkelt, 30° rückwärts, 19 Charr. Cutting loop electrode, angled, 30° backwards, 19 Fr.		ARS150-019-302
Kugelelektrode, Ø 3,0 mm, 19 Charr. Rollerball electrode, Ø 3.0 mm, 19 Fr.		ARS180-019-302
Rollenelektrode, Ø 3,0 mm, 19 Charr. Roller electrode, Ø 3.0 mm, 19 Fr.		ARS184-019-302
Messerelektrode, abgewinkelt, 19 Charr. Knife electrode, angled, 19 Fr.		ARS160-019-302
Schutzhülse für Elektroden, rostfreier Stahl Protecting sleeve for electrodes, stainless steel		AEA030-000-000
HF-Kabel, monopolar, für ERBE ACC/ICC, STORZ-Geräte HF cable, monopolar, for ERBE ACC/ICC, STORZ units		AHC014-050-300
Urethrotom nach OTIS für Erwachsene (klassisch) Urethrotome by OTIS for adults (classical)		60-782-000
Evakuator Evacuator		AEI100-000-000
Blasenspritze, 100 ml Bladder syringe, 100 ml		418-928-100

Laseranwendungen

Laser Applications

A-line
endoscopy



UROLOGY



...we can do it!



Laser-Cysto-Urethroskop-Set – Dauerspülung
Laser Cysto-Urethroscope set – Continuous-Flow

23 Charr. / Fr.



Endoskop / Endoscope				
Durchmesser Diameter	Blickrichtung Direction of view	Kennfarbe Colour code	Nutzlänge Working length	Bestell-Nr. Ordering number
	30°	rot / red	302 mm	AER300-040-030

Laser-Cysto-Urethroskopschaft mit 2 starren Hähnen – Dauerspülung
Laser Cysto-Urethroscope sheath with 2 fixed stopcocks – Continuous-Flow

Charr. Fr.	Kennfarbe Colour code	Bestell-Nr. Ordering number
23	blau / blue	ACU310-023-302

Untersuchungseinsatz mit 8 Charr. Instrumentenkanal für Laser-Cysto-Urethroskopschaft
Examination insert with 8 Fr. instrument channel for Laser Cysto-Urethroscope sheath

Charr. Fr.	Kennfarbe Colour code	Bestell-Nr. Ordering number
23	blau / blue	ACU326-023-302



Obturatoren für Laser-Cysto-Urethroskopschaft

Obturator for Laser Cysto-Urethroscope sheath

23 Charr. / Fr.



Standardobturator / Standard Obturator



Charr.
Fr.

Kennfarbe
Colour code

Bestell-Nr.
Ordering number

23

blau / blue

ACU320-023-302

Sichtobturator / Viewing Obturator



Charr.
Fr.

Kennfarbe
Colour code

Bestell-Nr.
Ordering number

23

blau / blue

ACU324-023-302











...we can do it!

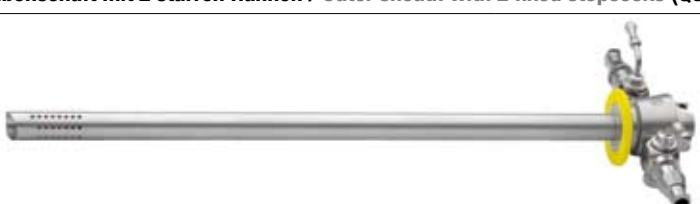

Laser-Resektoskop-Sets mit Dauerspül-Doppelschaft-System, feststehend
Laser Resectoscope sets with continuous flow double-sheath system, fixed

26 – 28,5 Charr. / Fr.

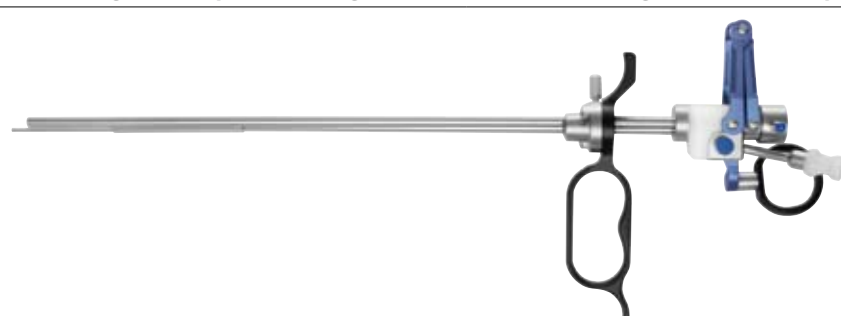

Endoskop / Endoscope				
				
Durchmesser Diameter	Blickrichtung Direction of view	Kennfarbe Colour code	Nutzlänge Working length	Bestell-Nr. Ordering number
	0°	rot / red	302 mm	AER300-040-000
	12°	rot / red	302 mm	AER300-040-012
	30°	rot / red	302 mm	AER300-040-030
Innenschaft / Inner sheath (QUICK LOCK)			Standardobturator / Standard Obturator	
				
24 Charr. / Fr.		ARS020-024-302	ARS080-024-302	
27 Charr. / Fr.		ARS020-027-302	ARS080-027-302	
Außenschaft mit 2 starren Hähnen / Outer sheath with 2 fixed stopcocks (QUICK LOCK)				
				
Perforation Perforation	 rundum surrounding		 nur oben/unten top/bottom only	
	 rundum gefenstert surrounding slits		 nur oben gefenstert slits on top only	
26 Charr. / Fr.	28,5 Charr. / Fr.	26 Charr. / Fr.	26 Charr. / Fr.	26 Charr. / Fr.
gelb / yellow	schwarz / black	gelb / yellow	gelb / yellow	gelb / yellow
ARS030-026-302	ARS030-028-302	ARS032-026-302	ARS034-026-302	ARS036-026-302
Arbeitselement, passiv schneidend, geschlossener Griff, Führungskanal für Lasersonden Working Element, passive cutting action, closed handle, Guiding channel for laser probes				
				
ARS300-040-302		für Lasersonden bis Ø 0,8 mm / for laser probes up to Ø 0.8 mm		
ARS300-140-302		für Lasersonden bis Ø 1,2 mm / for laser probes up to Ø 1.2 mm		



Laseranwendungen









Laser Applications

A-line
endoscopy

Laser-Resektoskop-Sets mit Dauerspül-Doppelschaft-System, drehbar
Laser Resectoscope sets with continuous flow double-sheath system, rotatable

26 – 28,5 Charr. / Fr.

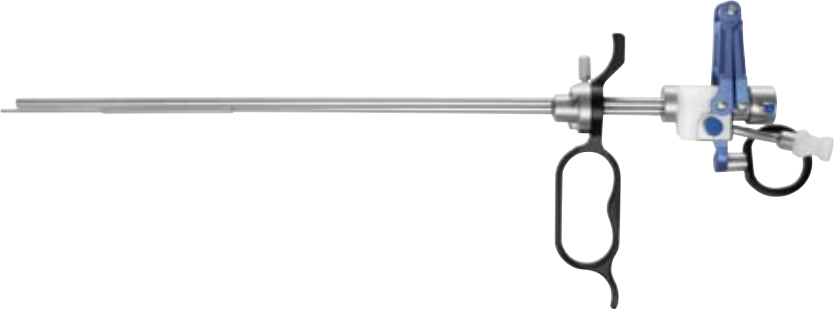

Endoskop / Endoscope				
				
Durchmesser Diameter	Blickrichtung Direction of view	Kennfarbe Colour code	Nutzlänge Working length	Bestell-Nr. Ordering number
	0°	rot / red	302 mm	AER300-040-000
	12°	rot / red	302 mm	AER300-040-012
	30°	rot / red	302 mm	AER300-040-030
Innenschaft / Inner sheath (QUICK LOCK)		Standardobturator / Standard Obturator		
				
24 Charr. / Fr.		ARS050-024-302	ARS080-024-302	
27 Charr. / Fr.		ARS050-027-302	ARS080-027-302	
Außenschaft mit 2 starren Hähnen / Outer sheath with 2 fixed stopcocks (QUICK LOCK)				
				
Perforation Perforation	 rundum surrounding		 nur oben/unten top/bottom only	
	 rundum gefenstert surrounding slits		 nur oben gefenstert slits on top only	
26 Charr. / Fr.	28,5 Charr. / Fr.	26 Charr. / Fr.	26 Charr. / Fr.	26 Charr. / Fr.
gelb / yellow	schwarz / black	gelb / yellow	gelb / yellow	gelb / yellow
ARS060-026-302	ARS060-028-302	ARS062-026-302	ARS064-026-302	ARS066-026-302
Arbeitselement, passiv schneidend, geschlossener Griff, Führungskanal für Lasersonden Working Element, passive cutting action, closed handle, Guiding channel for laser probes				
				
ARS300-040-302		für Lasersonden bis Ø 0,8 mm / for laser probes up to Ø 0.8 mm		
ARS300-140-302		für Lasersonden bis Ø 1,2 mm / for laser probes up to Ø 1.2 mm		



Arbeitselemente und Endoskopbrücke für Resektoskope
Working Elements and Endoscope Bridge for Resectoscopes

24 – 28,5 Charr. / Fr.



Arbeitselemente, passiv schneidend / Working Elements, passive cutting action



Schnitt erfolgt durch Federdruck / Spring-assisted cutting action



geschlossener Griff / closed handle

ARS100-040-302



offener Griff / open handle

ARS102-040-302

Endoskopbrücke
Endoscope Bridge



mit 1 x 5 Charr. Instrumentenkanal
with 1 x 5 Fr. instrument channel

AUT090-040-302

* für Elektroden und Küretten siehe "Resektoskopie" Seite 39
for Electrodes and Curettes please refer to „Resectoscopy“ page 39



...we can do it!



Laseranwendungen Laser Applications

A-line
endoscopy

Optische Gewebestanze für Resektoskopaußenschäfte
Optical Tissue Punch for Resectoscope outer sheaths

26 – 28,5 Charr. / Fr.



	Bestell-Nr. Ordering number
Optische Gewebestanze für Endoskope, 12°, 30° <i>Optical Tissue Punch for endoscopes, 12°, 30°</i>	ARS330-040-302



...we can do it!

Urethrotomie

Urethrotomy

A-line[®]
endoscopy



UROLOGY



...we can do it!



Klassisches Urethrotom für Erwachsene
Classical Urethrotome for adults

15 – 45 Charr. / Fr.

	
<p>Urethrotom nach OTIS / Urethrotome by OTIS – Nutzlänge / Working length 200 mm</p>	
	
<p>bestehend aus: OTIS Dilatationsgerät, 3 auswechselbare Spitzen (gerade, kugelförmig, gebogen), 2 Messer consisting of: OTIS Dilation device, 3 interchangeable tips (straight, spherical, curved), 2 knives</p>	
Bestell-Nr. / Ordering number	60-782-000
	
<p>OTIS Ersatzmesser / OTIS Spare Knife</p>	
Bestell-Nr. / Ordering number	60-782-001

Klassisches Urethrotom für Kinder
Classical Urethrotome for children

12 – 24 Charr. / Fr.

	
<p>Urethrotom nach KEITZER / Urethrotome by KEITZER *</p>	
<p>bestehend aus: KEITZER OTIS Dilatationsgerät, 2 Messer / consisting of: KEITZER OTIS Dilation device, 2 knives</p>	
Bestell-Nr. / Ordering number	60-780-000
<p>KEITZER Ersatzmesser / KEITZER Spare Knife</p>	
Bestell-Nr. / Ordering number	60-780-001

* Auch zur Meatotomie bei Erwachsenen / Also suitable for Meatotomy on adults









Urethrotomie

Urethrotomy

Optisches Urethrotom-Set

Optical Urethrotome set

21 Charr. / Fr.

Endoskop / Endoscope				
				
Durchmesser Diameter	Blickrichtung Direction of view	Kennfarbe Colour code	Nutzlänge Working length	Bestell-Nr. Ordering number
	0°	grün / green	302 mm	AER300-040-000
Urethrotomschaft mit 2 starren Hähnen / Urethrotome sheath with 2 fixed stopcocks				
				
21 Charr., mit 1 x 5 Charr. Instrumentenkanal / 21 Fr., with 1 x 5 Fr. instrument channel				AUT010-021-302
Standardobturator / Standard Obturator				
				
für Urethrotomschaft 21 Charr. / for Urethrotome sheath 21 Fr.				AUT080-021-302
Endoskopbrücke Endoscope Bridge	Arbeitselement, passiv schneidend Working Element, passive cutting action	Strikturskalpell * Stricture Scalpel		
				
mit 1 x 5 Charr. Instrumentenkanal with 1 x 5 Fr. instrument channel	Schnitt erfolgt durch Federdruck, geschl. Griff Spring-assisted cutting action, closed handle	21 Charr. / Fr.		
AUT090-040-302	ARS100-040-302	gerade / straight		
		AUT150-021-302		







* Nicht zur Verwendung mit Hochfrequenz-Strom! / Not to be used with high frequency current!



Obturatoren, Schäfte und Gummikappe für Urethrotomschäfte
Obturator, sheaths and rubber cap für Urethrotome sheaths

21 Charr. / Fr.

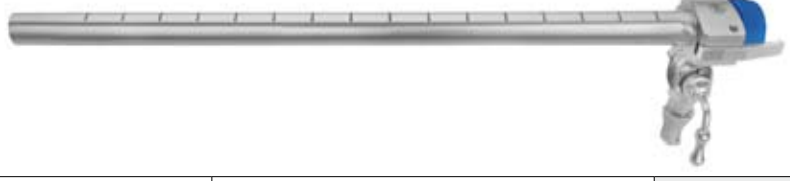

Charr. Fr.	Instr.-Kanal Instr. channel	Bestell-Nr. Ordering number
	Durchlass / Charr. Capacity / Fr.	
Standardobturator / Standard Obturator		
		
21		AUT080-021-302
Obturator mit Instrumentenkanal / Obturator with instrument channel		
		
21	5	AUT086-021-302
Sichtobturator / Viewing Obturator		
		
21		AUT084-021-302
Führungsrohr für Urethrotomschaft / Guide Tube for Urethrotome sheath		
		
seitlich offen, zum Einführen eines Ballonkatheters / laterally open, for insertion of a balloon catheter		
21		AUT040-021-302
Urethrotom-Zusatzschaft für Dauerspülung / Supplementary Urethrotome sheath for continuous irrigation		
		
25		AUT030-025-302
Gummikappe / Rubber Cap		
		
für Instrumentenkanal / for instrument channel		AEA010-010-000



Urethrotomie

Urethrotomy

A-line
endoscopy

Arbeitselemente für Urethrotom
Working Elements for Urethrotome

21 Charr. / Fr.



Arbeitselemente, passiv schneidend / Working Elements, passive cutting action



Schnitt erfolgt durch Federdruck / Spring-assisted cutting action



geschlossener Griff / closed handle

ARS100-040-302



offener Griff / open handle

ARS102-040-302









...we can do it!



Strikturskalpelle für Urethrotom zum kalten Schneiden von Harnröhrenstrikturen
Stricture Scalpels for Urethrotome for cold cutting of urethral strictures

21 Charr. / Fr.



	
gerade / straight *	gerade, Wellenschliff / straight, wave-shaped *
	
21 Charr. / Fr.	21 Charr. / Fr.
AUT150-021-302	AUT152-021-302
rund / round *	sichelförmig / sickle-shaped *
	
21 Charr. / Fr.	21 Charr. / Fr.
AUT160-021-302	AUT170-021-302
ringförmig / ring-shaped *	Schutzhülse, rostfreier Stahl / Protecting Sleeve, stainless steel
	
21 Charr. / Fr.	für die Sterilisation und Aufbewahrung / for sterilization and storage
AUT180-021-302	AEA030-000-000

* Nicht zur Verwendung mit Hochfrequenz-Strom! / Not to be used with high frequency current!









Urethrotomie

Urethrotomy

Optisches Urethrotom-Set

Optical Urethrotome set

17 Charr. / Fr.

Endoskop / Endoscope				
				
Durchmesser Diameter	Blickrichtung Direction of view	Kennfarbe Colour code	Nutzlänge Working length	Bestell-Nr. Ordering number
	0°	grün / green	302 mm	AER150-029-000
Urethrotomschaft mit 2 starren Hähnen / Urethrotome sheath with 2 fixed stopcocks				
				
17 Charr., mit 1 x 5 Charr. Instrumentenkanal / 17 Fr., with 1 x 5 Fr. instrument channel				AUT010-017-302
Standardobturator / Standard Obturator				
				
für Urethrotomschaft 17 Charr. / for Urethrotome sheath 17 Fr.				AUT080-017-302
Endoskopbrücke Endoscope Bridge	Arbeitselement, passiv schneidend Working Element, passive cutting action	Strikturskalpell * Stricture Scalpel		
				
mit 1 x 5 Charr. Instrumentenkanal with 1 x 5 Fr. instrument channel	Schnitt erfolgt durch Federdruck, geschl. Griff Spring-assisted cutting action, closed handle	17 Charr. / Fr.		
AUT090-029-302	ARS100-029-302	gerade / straight		
		AUT150-017-302		



* Nicht zur Verwendung mit Hochfrequenz-Strom! / Not to be used with high frequency current!



Obturator, Schaft und Gummikappe für Urethrotomschaft
Obturator, sheath and rubber cap für Urethrotome sheath

17 Charr. / Fr.



Charr. Fr.	Instr.-Kanal Instr. channel	Bestell-Nr. Ordering number
	Durchlass / Charr. Capacity / Fr.	
Standardobturator / Standard Obturator		
		
17		AUT080-017-302
Führungsrohr für Urethrotomschaft / Guide Tube for Urethrotome sheath		
		
seitlich offen, zum Einführen eines Ballonkatheters / laterally open, for insertion of a balloon catheter		
17		AUT040-017-302
Gummikappe / Rubber Cap		
		
für Instrumentenkanal / for instrument channel		AEA010-010-000



Urethrotomie

Urethrotomy

A-line
endoscopy

Arbeitselemente für Urethrotom
Working Elements for Urethrotome

17 Charr. / Fr.



Arbeitselemente, passiv schneidend / Working Elements, passive cutting action



Schnitt erfolgt durch Federdruck / Spring-assisted cutting action



geschlossener Griff / closed handle

ARS100-029-302



offener Griff / open handle

ARS102-029-302



...we can do it!



Strikturskalpelle für Urethrotom zum kalten Schneiden von Harnröhrenstrikturen
Stricture Scalpels for Urethrotome for cold cutting of urethral strictures

17 Charr. / Fr.



gerade / straight *	gerade, Wellenschliff / straight, wave-shaped *
17 Charr. / Fr.	17 Charr. / Fr.
AUT150-017-302	AUT152-017-302
rund / round *	sichelförmig / sickle-shaped *
17 Charr. / Fr.	17 Charr. / Fr.
AUT160-017-302	AUT170-017-302
Schutzhülse, rostfreier Stahl / Protecting Sleeve, stainless steel	
für die Sterilisation und Aufbewahrung / for sterilization and storage	
AEA030-000-000	

* Nicht zur Verwendung mit Hochfrequenz-Strom! / Not to be used with high frequency current!



Urethrotomie

Urethrotomy















A-line
endoscopy



Basis-Set für optische Urethrotomie

Basic set for optical Urethrotomy

21 Charr. / Fr.

Artikelbezeichnung Article description	Produkt Product	Bestell-Nr. Ordering number
Komplett-Set Complete Set		ASE280-040-010
Endoskop 4,0 mm / 0°, 302 mm Endoscope 4,0 mm / 0°, 302 mm		AER300-040-000
Urethrotomschaft mit 1 x 5 Charr. Instrumentenkanal, 21 Charr. Urethrotome sheath with 1 x 5 Fr. instrument channel, 21 Fr.		AUT010-021-302
Standardobturator Standard obturator		AUT080-021-302
Führungsrohr, seitlich offen für die Einführung eines Ballonkatheters Guiding tube, laterally open for the insertion of a balloon catheter		AUT040-021-302
Endoskopbrücke mit 1 x 5 Charr. Instrumentenkanal Endoscope bridge with 1 x 5 Fr. instrument channel		AUT090-040-302
Arbeitselement, passiv schneidend Working element, passive cutting action		ARS100-040-302
Strikturskalpell, gerade, 21 Charr. Stricture scalpel, straight, 21 Fr.		AUT150-021-302
Strikturskalpell, gerade, Wellenschliff, 21 Charr. Stricture scalpel, straight, wave-shaped, 21 Fr.		AUT152-021-302
Strikturskalpell, rund, 21 Charr. Stricture scalpel, round, 21 Fr.		AUT160-021-302
Strikturskalpell, hakenförmig / sichelförmig, 21 Charr. Stricture scalpel, hook-shaped / sickle-shaped, 21 Fr.		AUT170-021-302
Strikturskalpell, ringförmig, 21 Charr. Stricture scalpel, ring-shaped, 21 Fr.		AUT180-021-302
Schutzhülse für Strikturskalpell, rostfreier Stahl Protecting sleeve for stricture scalpels, stainless steel		AEA030-000-000
Urethrotom nach OTIS für Erwachsene (klassisch) Urethrotome by OTIS for adults (classical)		60-782-000
Blasenspritze, 150 ml Bladder syringe, 150 ml		418-928-150

Uretero-Renoskopie

Uretero-Renoscopia

A-line
endoscopy



UROLOGY









...we can do it!



Uretero-Renokope, halbstarr
Uretero-Renoscopes, semi-rigid

6,0 – 7,5 Charr. / Fr.







Durchmesser * / Einblick Diameter * / Insight	Blickrichtung Direction of view	Kennfarbe Colour code	Instr.-Kanal Instr. channel	Nutzlänge Working length	Bestell-Nr. Ordering number
			Durchlass / Charr. Capacity / Fr.		
seitlich versetzter Einblick / laterally offset eyepiece  	8°	schwarz / black	1 x 5 / 2 x 3	425 mm	AES150-075-008
				310 mm	AES140-075-008
seitlich versetzter Einblick / laterally offset eyepiece  	8°	schwarz / black	1 x 4 / 2 x 2,4	425 mm	AES130-060-008
				310 mm	AES120-060-008
Führungsadapter für Lithotripsie-Handstück / Guide Adaptor for Lithotripsy handle					
					AUR810-000-000
Gummikappe für Instrumentenkanal / Rubber Cap for instrument channel					
					AEA010-010-000
Flexible Reinigungsbürsten / Flexible Cleaning Brushes					
	Ø 1,2 mm	für Instrumentenkanal	≥ Ø 1,0 mm	600 mm	AEA800-212-060
	Ø 2,0 mm	for instrument channel	≥ Ø 1,5 mm	600 mm	AEA800-220-060

* 7,5 Charr. / Fr. → Querschnitt / cross-section distal 10 Charr. / Fr.

* 6,0 Charr. / Fr. → Querschnitt / cross-section distal 8 Charr. / Fr.

Weitere Modelle auf Anfrage. / Further models upon request.

Uretero-Renoscope, HD, halbstarr
Uretero-Renoscopes, HD, semi-rigid
6,0 – 12 Charr. / Fr.

Durchmesser / Einblick Diameter / Insight	Blickrichtung Direction of view	Kennfarbe Colour code	Instr.-Kanal Instr. channel	Nutzlänge Working length	Bestell-Nr. Ordering number
			Durchlaß / Charr. Capacity / Fr.		
seitlicher Einblick / oblique eyepiece   40 000 Pixel	0° - 12°	weiß / white	6,8 1 x 5 / 2 x 3	150 mm	AES302-040-000
				310 mm	AES304-040-000
				425 mm	AES306-040-000
seitlicher Einblick / oblique eyepiece   17 000 Pixel	0° - 12°	weiß / white	5,1 1 x 4 / 2 x 2,4	140 mm	AES202-030-000
				310 mm	AES204-030-000
				425 mm	AES206-030-000

Flexible Reinigungsbürsten → siehe Seite 72

Flexible Cleaning Brushes → please refer to page 72



Zangen, flexibel, isoliert und halbstarr
Forceps, flexible, insulated and semi-rigid

Nutzlänge 600 mm Working length 600 mm	Durchmesser / Diameter		flexibel flexible	flexibel isoliert flexible insulated	halbstarr semi-rigid
	mm	Charr. / Fr.			
Fremdkörperzange, Alligatormaul, doppelbeweglich / Foreign body forceps, alligator jaw, double action					
	1,0 mm	3	AFF204-210-060		AFF204-610-060
	1,6 mm	5	AFF204-216-060	AFF204-416-060	AFF204-616-060
Probeexzisions- und Fasszange, oval, gezahnt, doppelbeweglich / Biopsy and grasping forceps, oval, serrated, double action					
	1,6 mm	5	AFF203-216-060	AFF203-416-060	AFF203-616-060
Fasszange für Steinstrasse, doppelbeweglich / Grasping forceps for large stone fragments, double action					
	1,6 mm	5	AFF208-216-060	AFF208-416-060	AFF208-616-060
Probeexzisionszange, oval, doppelbeweglich / Biopsy forceps, oval, double action					
	1,0 mm	3	AFF200-210-060		AFF200-610-060
	1,6 mm	5	AFF200-216-060	AFF200-416-060	AFF200-616-060
Schere, flexibel, einfachbeweglich / Scissors, flexible, single action					
	1,6 mm	5	AFF201-216-060	AFF201-416-060	AFF201-616-060

Weitere Modelle auf Anfrage. / Further models upon request.



Uretero-Renoskopie

Uretero-Renoscropy

Flexible Steinfänger

Flexible stone extractors

	Durchmesser / Diameter		Drähte wires	Nutzlänge Working length	Bestell-Nr. Ordering number
	mm	Charr. / Fr.			
Steinfänger / Stone Extractor					
	0,8	2,5	4	600 mm	AFI210-208-060
	1,0	3	4	600 mm	AFI210-210-060
	1,6	5	4	600 mm	AFI210-216-060
			5	600 mm	AFI210-416-060
			6	600 mm	AFI210-616-060
Griff alleine für Steinfänger / Handle only for Stone Extractor					
	0,8	2,5	4	600 mm	AFI210-016-000
	1,0	3	4	600 mm	
	1,6	5	4 – 6	600 mm	

Weitere Modelle auf Anfrage. / Further models upon request.



Flexible Elektroden, monopolar
Flexible Electrodes, monopolar

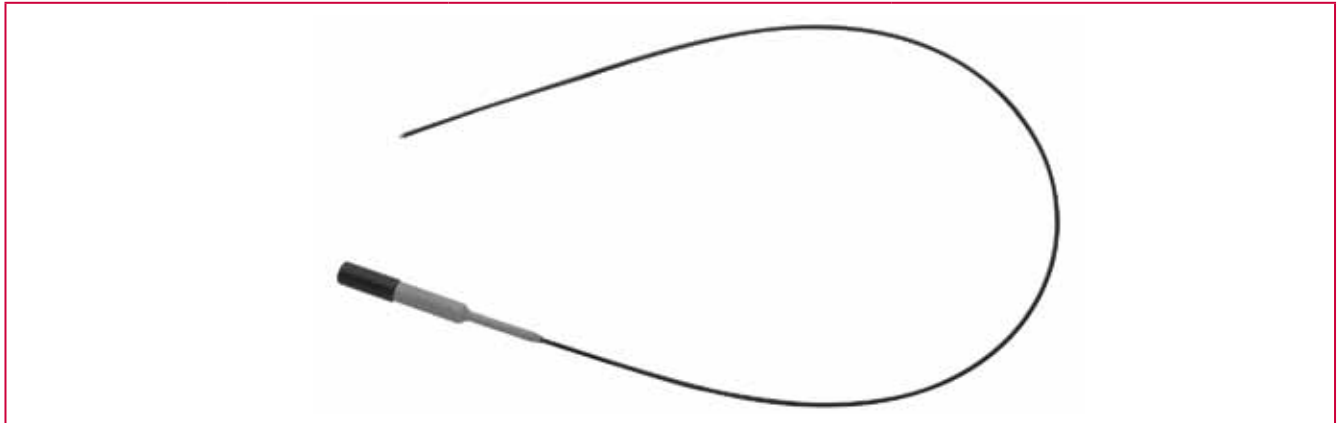

Nadelelektrode / Needle Electrode



Durchmesser / Diameter		Nutzlänge / Working length	Bestell-Nr. / Ordering number
mm	Charr. / Fr.		
1,0	3	450 mm	AHI010-410-045
1,6	5	450 mm	AHI010-416-045
1,0	3	650 mm	AHI010-410-065
1,6	5	650 mm	AHI010-416-065

Knopfelektrode / Button Electrode



1,0	3	450 mm	AHI020-410-045
1,3	4	450 mm	AHI020-413-045
1,6	5	450 mm	AHI020-416-045
1,0	3	650 mm	AHI020-410-065
1,3	4	650 mm	AHI020-413-065
1,6	5	650 mm	AHI020-416-065

Schlingenelektrode / Loop Electrode



1,6	5	450 mm	AHI030-416-045
1,6	5	650 mm	AHI030-416-065

Weitere Nutzlängen auf Anfrage. / Further working lengths upon request.



...we can do it!



Uretero-Renoskopie

Uretero-Renoscropy

A-line
endoscopy

Hochfrequenz-Kabel, monopolar

High-Frequency Cables, monopolar











instrumentenseitig instrument side	geräteseitig equipment side	Durchmesser Diameter	Länge Length	Bestell-Nr. Ordering number
		4 mm	3 m	AHC010-040-300
	Für Geräte von Berchtold, Martin, Aesculap For Berchtold, Martin, Aesculap units			
		4 mm	3 m	AHC012-040-300
	Für Geräte von Berchtold, Martin, Erbe T-Serie For Berchtold, Martin, Erbe T-Series units			
		5 mm	3 m	AHC014-050-300
	Für Geräte von Erbe ACC/ICC, Storz For Erbe ACC/ICC, Storz units			
	8 mm	3 m	AHC016-080-300	
Für Geräte von Valleylab, Bovie, Conmed For Valleylab, Bovie, Conmed units				

Weitere Kabel auf Anfrage. / Further cables upon request.



Basis-Set für Uretero-Renoskopie, halbstarr
Basic set for Uretero-Renoscropy, semi-rigid



Artikelbezeichnung Article description	Produkt Product	Bestell-Nr. Ordering number
Komplett-Set Complete Set		ASE280-050-010
Uretero-Renoskop, 8°, seitlich versetzter Einblick, 2 Spülhähne, Instrumentenkanal 1 x 5 / 2 x 3 Charr., 425 mm, 7,5 Charr. Uretero-Renoscope, 8°, laterally offset eyepiece, 2 irrigation channels, instrument channel 1 x 5 / 2 x 3 Fr., 425 mm, 7,5 Fr.		AES150-075-008
Führungsadapter für Lithotripsie-Handstück Guide adaptor for lithotripsy handle		AUR810-000-000
Flexible Fass-/Fremdkörperzange, Alligatormaul, 600 mm, 5 Charr. Flexible grasping/foreign body forceps, Alligator jaw, 600 mm, 5 Fr.		AFF204-216-060
Flexible Schere, 600 mm, 5 Charr. Flexible scissors, 600 mm, 5 Fr.		AFF201-216-060
Flexible Probeexcisions- und Fasszange, gezahnt, 600 mm, 5 Charr. Flexible biopsy and grasping forceps, serrated, 600 mm, 5 Fr.		AFF203-216-060
Flexible Fasszange mit 8 mm Maulteil, gezahnt, 600 mm, 5 Charr. Flexible grasping forceps with jaw 8 mm, serrated, 600 mm, 5 Fr.		AFF208-216-060
Flexibler Steinfänger, komplett mit Griff, 600 mm, 5 Charr. Flexible stone extractor, complete with handle, 600 mm, 5 Fr.		AFI210-016-000 AFI210-216-060
Siebkorb für 1 Endoskop, Lichtleitkabel inkl. Kleinteilekorb, 640 x 150 x 77 mm Wire basket for 1 endoscope, cold light cable incl. basket for small parts, 640 x 150 x 77 mm		74-600-080



Uretero-Renoskopie







Uretero-Renoscapy

A-line
endoscopy



Basis-Set für Uretero-Renoskopie, HD, halbstarr

Basic set for Uretero-Renoscapy, HD, semi-rigid

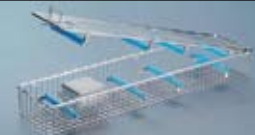
Artikelbezeichnung Article description	Produkt Product	Bestell-Nr. Ordering number
Komplett-Set Complete Set		ASE280-050-020
Uretero-Renoskop, 0°-12°, weiß, 40.000 Pixel Instrumentenkanal 6,8 für 1 x 5 / 2 x 3 Charr., 425 mm, 7,5-9-12 Charr. Uretero-Renoscope, 0°-12°, white, 40.000 Pixel instrument channel 6,8 for 1 x 5 / 2 x 3 Fr., 425 mm, 7,5-9-12 Fr.		AES306-040-000
Flexible Fass-/Fremdkörperzange, Alligatormaul, 600 mm, 5 Charr. Flexible grasping/foreign body forceps, Alligator jaw, 600 mm, 5 Fr.		AFF204-216-060
Flexible Schere, 600 mm, 5 Charr. Flexible scissors, 600 mm, 5 Fr.		AFF201-216-060
Flexible Probeexcisions- und Fasszange, gezahnt, 600 mm, 5 Charr. Flexible biopsy and grasping forceps, serrated, 600 mm, 5 Fr.		AFF203-216-060
Flexible Fasszange mit 8 mm Maulteil, gezahnt, 600 mm, 5 Charr. Flexible grasping forceps with jaw 8 mm, serrated, 600 mm, 5 Fr.		AFF208-216-060
Flexibler Steinfänger, komplett mit Griff, 5 Charr., 600 mm, 5 Charr. Flexible stone extractor, complete with handle, 600 mm, 5 Fr.		AFI210-016-000 AFI210-216-060
Siebkorb für 1 Endoskop, Lichtleitkabel inkl. Kleinteilekorb, 640 x 150 x 77 mm Wire basket for 1 endoscope, cold light cable incl. basket for small parts, 640 x 150 x 77 mm		74-600-080

Perkutane Nephroskopie

Percutaneous Nephroscopy

A-line[®]
endoscopy



UROLOGY









...we can do it!



Perkutane Nephroskope mit Dauerspülsystem
Percutaneous Nephrosopes with continuous flow system

24 – 26 Charr. / Fr.



 					
Durchmesser * / Einblick Diameter * / Insight	Blickrichtung Direction of view	Kennfarbe Colour code	Instr.-Kanal Instr. channel	Nutzlänge Working length	Bestell-Nr. Ordering number
			Durchlass / mm Capacity / mm		
 Schrägeinblick oblique view	0°	grün / green	Ø 4,9	200 mm	AER520-074-000
				250 mm	AER530-074-000
 Paralleleinblick parallel view	0°	grün / green	Ø 4,9	200 mm	AER525-074-000
				250 mm	AER535-074-000
Adapter mit Hahn / Adaptor with stopcock					
			5,0 mm		ANE810-050-000
Dichtungskappe Sealing Cap			für Adapter for Adaptor	zum Gebrauch ohne Adapter for use without adaptor	Bestell-Nr. Ordering number
			Ø 15/2 mm		ANE830-152-000
				Ø 20/2 mm	ANE835-202-000

* Quick-Lock System und weitere Modelle auf Anfrage. / Quick-Lock System and further models upon request.



Perkutane Nephroskopie

Percutaneous Nephroscopy

A-line
endoscopy

Schäfte und Obturatoren für perkutane Nephroskope

Sheaths and Obturators for percutaneous Nephroscopes

24 – 26 Charr. / Fr.



Nephroskopschaft mit drehbarem Hahn / Nephroscope sheath with rotatable stopcock						
Charr. Fr.	Kennfarbe Colour code	Instr.-Kanal Instr. channel	Distal perforiert distally perforated		für Endoskoplänge for Endoscope length	Bestell-Nr. Ordering number
		Durchlass / mm Capacity / mm	Ja / Yes	Nein / No		
24	rot / red	3,5 mm		x	200 mm	ANE012-024-200
26 (w) *	blau / blue	4,9 mm		x	200 mm	ANE032-026-200
26 (w) *	blau / blue	4,9 mm		x	250 mm	ANE042-026-250
Obturator (hohl) / Obturator (hollow)						
24	rot / red				200 mm	ANE086-024-200
26 (w) *	blau / blue				200 mm	ANE086-026-200
26 (w) *	blau / blue				250 mm	ANE086-026-250

Quick-Lock System und weitere Modelle auf Anfrage. / Quick-Lock System and further models upon request.

* (w) = aufgeweitet / widened







...we can do it!



Teleskop-Dilatatoren und Reinigungsbürsten für perkutane Nephroskope

Telescope-Dilators and Cleaning Brushes for percutaneous Nephroscopes

				
Teleskop-Dilatator-Set – standard – bestehend aus 6 Dilatatoren (9 – 24 Charr.), je 1 starre und flexible Führungssonde Telescope-Dilator set – standard – consisting of 6 Dilators (9 – 24 Fr.), 1 rigid and flexible guide probe each	Charr. Fr.	Führungssonde Guide probe		Bestell-Nr. Ordering number
		starr / rigid	flexibel / flexible	
	9	1 x	1 x	ANE200-024-000
	12			
	15			
	18			
	21			
	24			
Weiterer Dilatator (Hülsen) / Further Dilator (sleeves)				
	27			ANE204-027-000
	30			ANE204-030-000
Führungssonde, alleine / Guide probe, only				
		x		ANE210-000-000
			x	ANE214-000-000
Reinigungsbürste / Cleaning Brush				
	3 mm	Spülkanal irrigation channel		AEA900-030-000
	6 mm	Instr.-Kanal Instr. channel		AEA900-060-000









Perkutane Nephroskopie

Percutaneous Nephroscopy

A-line
endoscopy

Instrumente für die perkutane Nephroskopie

Instruments for percutaneous Nephroscopy











			
Nutzlänge 420 mm Working length 420 mm	Durchmesser Diameter	Charr. Fr.	Bestell-Nr. Ordering number
Fasszange für Biopsie, Löffel oval, einseitig öffnend / Grasping forceps for biopsy, oval spoon, single action			
	3 mm	9	ANE150-603-042
Fasszange für Steinfragmente, gefenstert, doppelbeweglich / Grasping forceps for stone fragments, fenestrated, double action			
	3 mm	9	ANE160-603-042
Fasszange für Steinfragmente, doppelbeweglich, Hechtmaul / Grasping forceps for stone fragments, double action, pike jaw			
	3 mm	9	ANE164-603-042
Mikroschere, gerade, einseitig öffnend / Micro-scissors, straight, single action			
	3 mm	9	ANE170-603-042
			
Dreigreifer für grössere Steinfragmente, mit Fixierzähnen und U-Federgriff Threefold grasper for large stone fragments, with fixation teeth and U-spring handle			
	3 mm	9	ANE180-603-042



Basis-Set für perkutane Nephroskopie
Basic set for percutaneous Nephroscopy

26 Charr. / Fr.



Artikelbezeichnung Article description	Produkt Product	Bestell-Nr. Ordering number
Komplett-Set Complete Set		ASE280-060-010
Nephroskop 7,4 x 4,5 mm, 0°, Paralleleinblick, 2 integrierte Spülkanäle und 1 Instrumentenkanal, 200 mm Nephroscope, 7,4 x 4,5 mm, 0° parallel view, 2 integrated irrigation channels and 1 instrument channel, 200 mm		AER525-074-000
Adapter mit Hahn für Nephroskop Adaptor with stopcock for Nephroscope		ANE810-050-000
Nephroskopschaft mit drehbarem Hahn, 26 Charr. Nephroscope sheath with rotatable stopcock, 26 Fr.		ANE032-026-200
Obturator, hohl, 26 Charr. Obturator, hollow, 26 Fr.		ANE086-026-200
Teleskop-Dilatator-Set, standard, 9 – 24 Charr. Telescope-dilator set, standard, 9 – 24 Fr.		ANE200-024-000
Fasszange für Steinfragmente, gefensterter, 3 mm, 420 mm Grasping forceps for stone fragments, fenestrated, 3 mm, 420 mm		ANE160-603-042
Fasszange für Steinfragmente, Hechtmaul, 3 mm, 420 mm Grasping forceps for stone fragments, pike jaw, 3 mm, 420 mm		ANE164-603-042
Fasszange für Biopsie, Löffel oval, 3 mm, 420 mm Grasping forceps for biopsy, oval spoon, 3 mm, 420 mm		ANE150-603-042
Mikroschere, gerade, 3 mm, 420 mm Micro-scissors, straight, 3 mm, 420 mm		ANE170-603-042
Dreigreifer für grössere Steinfragmente, Fixierzähne und U-Federgriff, 3 mm, 420 mm Threefold grasper for large stone fragments, fixation teeth and U-spring handle, 3 mm, 420 mm		ANE180-603-042

Notizen
Notes

Kinder Urologie

Pediatric Urology

A-line
endoscopy



UROLOGY









...we can do it!



Kinder-Cysto-Urethroskop-Set, Endoskope starr
Pediatric Cysto-Urethroscope set, Endoscopes rigid

13 Charr. / Fr.

Endoskop / Endoscope				
				
Durchmesser Diameter	Blickrichtung Direction of view	Kennfarbe Colour code	Nutzlänge Working length	Bestell-Nr. Ordering number
	0°	grün / green	187,5 mm	AER140-027-000
	30°	rot / red	187,5 mm	AER140-027-030
	70°	gelb / yellow	187,5 mm	AER140-027-070
Schaft mit 2 starren Hähnen inkl. Standardobturator, 1 Instr.-Kanal / Sheath with 2 fixed stopcocks incl. Standard Obturator, 1 Instr. channel				
				
Charr. Fr.	Kennfarbe Colour code	Instr.-Kanal Instr. channel	Durchlass / Charr. Capacity / Fr.	Bestell-Nr. Ordering number
13	rot / red	1 x 3		ACU010-013-187
Standardobturator / Standard Obturator				
				
13	rot / red			ACU080-013-187
Endoskopbrücke Endoscope Bridge		Arbeitseinsatz mit ALBARRAN-Lenkhebel Working element with ALBARRAN deflector		
				
zur Verwendung mit Schaft 13 Charr. / to be used with sheath 13 Fr.		zur Verwendung mit Schaft 13 Charr. / to be used with sheath 13 Fr.		
ACU100-027-187		ACU120-027-187		



Kinder Urologie

Pediatric Urology

Kinder-Cysto-Urethroskop-Set, Endoskope starr oder halbstarr

Pediatric Cysto-Urethroscope set, Endoscopes rigid or semi-rigid





11 Charr. / Fr.

Endoskop / Endoscope				
Durchmesser Diameter	Blickrichtung Direction of view	Kennfarbe Colour code	Nutzlänge Working length	Bestell-Nr. Ordering number
	0°	grün / green	187,5 mm	AER140-027-000
	30°	rot / red	187,5 mm	AER140-027-030
	70°	gelb / yellow	187,5 mm	AER140-027-070
	0°	grün / green	187,5 mm	AES140-020-000
	30°	rot / red	187,5 mm	AES140-020-030
Schaft mit 2 starren Hähnen inkl. Standardobturator, 1 Instr.-Kanal / Sheath with 2 fixed stopcocks incl. Standard Obturator, 1 Instr. channel				
Charr. Fr.	Kennfarbe Colour code	Instr.-Kanal Instr. channel	Durchlass / Charr. Capacity / Fr.	Bestell-Nr. Ordering number
11	grün / green	1 x 3	bei Verwendung mit 2,7 mm Endoskop for use with 2,7 mm Endoscope	ACU010-011-187
		1 x 5	bei Verwendung mit 2,0 mm Endoskop for use with 2,0 mm Endoscope	
Standardobturator / Standard Obturator				
11	grün / green			ACU080-011-187



Kinder-Cysto-Urethroskop-Set, Endoskope halbstarr
Pediatric Cysto-Urethroscope set, Endoscopes semi-rigid

9,5 Charr. / Fr.

Endoskope / Endoscopes				
				
Durchmesser Diameter	Blickrichtung Direction of view	Kennfarbe Colour code	Nutzlänge Working length	Bestell-Nr. Ordering number
	0°	grün / green	187,5 mm	AES140-020-000
	30°	rot / red	187,5 mm	AES140-020-030
Schaft mit 2 starren Hähnen inkl. Standardobturator, 1 Instr.-Kanal / Sheath with 2 fixed stopcocks incl. Standard Obturator, 1 Instr. channel				
				
Charr. Fr.	Kennfarbe Colour code	Instr.-Kanal Instr. channel	Durchlass / Charr. Capacity / Fr.	Bestell-Nr. Ordering number
9,5	blau / blue	1 x 3 Charr. / Fr.		ACU010-009-187
Standardobturator / Standard Obturator				
				
9,5	blau / blue			ACU080-009-187



Zangen, flexibel, isoliert und halbstarr
Forceps, flexible, insulated and semi-rigid

Nutzlänge 280 mm Working length 280 mm	Durchmesser / Diameter		flexibel flexible	flexibel isoliert flexible insulated	halbstarr semi-rigid
	mm	Charr. / Fr.			
Fremdkörperzange, Alligatormaul, doppelbeweglich / Foreign body forceps, alligator jaw, double action					
	1,0 mm	3	AFF204-210-028		AFF204-610-028
	1,6 mm	5	AFF204-216-028	AFF204-416-028	AFF204-616-028
Probeexzisions- und Fasszange, oval, gezahnt, doppelbeweglich / Biopsy and grasping forceps, oval, serrated, double action					
	1,6 mm	5	AFF203-216-028	AFF203-416-028	AFF203-616-028
Probeexzisionszange, oval, doppelbeweglich / Biopsy forceps, oval, double action					
	1,0 mm	3	AFF200-210-028		AFF200-610-028
	1,6 mm	5	AFF200-216-028	AFF200-416-028	AFF200-616-028
Schere, einfachbeweglich / Scissors, single action					
	1,6 mm	5	AFF201-216-028	AFF201-416-028	AFF201-616-028

Weitere Modelle auf Anfrage. / Further models upon request.



...we can do it!



Flexible Elektroden, monopolar
Flexible Electrodes, monopolar

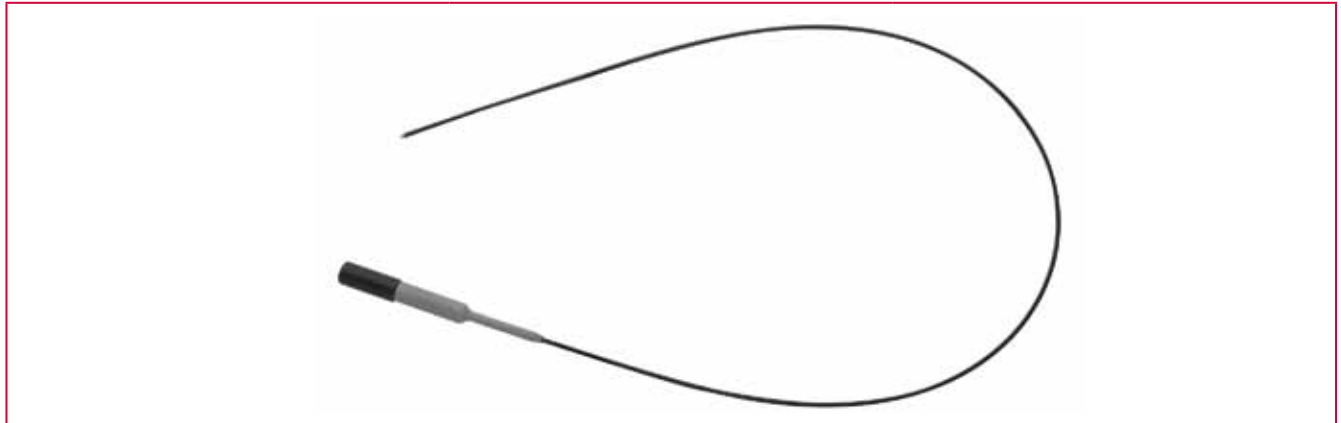

Nadelelektrode / Needle Electrode



Durchmesser / Diameter		Nutzlänge / Working length	Bestell-Nr. / Ordering number
mm	Charr. / Fr.		
1,0	3	450 mm	AHI010-410-045
1,6	5	450 mm	AHI010-416-045

Knopfelektrode / Button Electrode



1,0	3	450 mm	AHI020-410-045
1,3	4	450 mm	AHI020-413-045
1,6	5	450 mm	AHI020-416-045

Schlingenelektrode / Loop Electrode



1,6	5	450 mm	AHI030-416-045
-----	---	--------	----------------

Weitere Nutzlängen auf Anfrage. / Further working lengths upon request.



Hochfrequenz-Kabel, monopolar

High-Frequency Cables, monopolar



instrumentenseitig instrument side	geräteseitig equipment side	Durchmesser Diameter	Länge Length	Bestell-Nr. Ordering number
		4 mm	3 m	AHC010-040-300
	Für Geräte von Berchtold, Martin, Aesculap For Berchtold, Martin, Aesculap units			
		4 mm	3 m	AHC012-040-300
	Für Geräte von Berchtold, Martin, Erbe T-Serie For Berchtold, Martin, Erbe T-Series units			
		5 mm	3 m	AHC014-050-300
	Für Geräte von Erbe ACC/ICC, Storz For Erbe ACC/ICC, Storz units			
		8 mm	3 m	AHC016-080-300
	Für Geräte von Valleylab, Bovie, Conmed For Valleylab, Bovie, Conmed units			

Weitere Kabel auf Anfrage. / Further cables upon request.









...we can do it!



Kinder-Resektoskop-Set, Endoskop starr
Pediatric Resectoscope set, Endoscope rigid

13 Charr. / Fr.

Endoskop / Endoscope				
				
Durchmesser Diameter	Blickrichtung Direction of view	Kennfarbe Colour code	Nutzlänge Working length	Bestell-Nr. Ordering number
	0°	grün / green	187,5 mm	AER140-027-000
Schaft mit 1 drehbaren Hahn inkl. Standardobturator / Sheath with 1 rotatable stopcock incl. Standard Obturator				
				
Charr. Fr.	Kennfarbe Colour code	Bestell-Nr. Ordering number		
13	rot / red	ARS010-013-187		
Standardobturator / Standard Obturator				
				
13 Charr. / Fr.	rot / red	ARS080-013-187		
Endoskopbrücke mit 3 Charr. Instrumentenkanal <i>Endoscope bridge with 3 Fr. instrument channel</i>	Arbeitselement, passiv schneidend <i>Working Element, passive cutting action</i>	Schlingenelektrode, abgewinkelt <i>Loop electrode, angled</i>		
				
	Schnitt erfolgt durch Federdruck, offener Griff Spring-assisted cutting action, open handle	13 Charr. / Fr.		
		rot / red		
AUT090-027-187	ARS100-027-187	ARS150-013-187		









Kinder Urologie

Pediatric Urology

Kinder-Resektoskop-Set, Endoskop halbstarr

Pediatric Resectoscope set, Endoscope semi-rigid

11 Charr. / Fr.

Endoskop / Endoscope				
				
Durchmesser Diameter	Blickrichtung Direction of view	Kennfarbe Colour code	Nutzlänge Working length	Bestell-Nr. Ordering number
	0°	grün / green	187,5 mm	AES140-020-000
Schaft mit 1 drehbaren Hahn inkl. Standardobturator / Sheath with 1 rotatable stopcock incl. Standard Obturator				
				
Charr. Fr.	Kennfarbe Colour code	Bestell-Nr. Ordering number		
11	grün / green	ARS010-011-187		
Standardobturator / Standard Obturator				
				
11 Charr. / Fr.	grün / green	ARS080-011-187		
Endoskopbrücke mit 3 Charr. Instrumentenkanal Endoscope bridge with 3 Fr. instrument channel	Arbeitselement, passiv schneidend Working Element, passive cutting action	Schlingenelektrode, abgewinkelt Loop electrode, angled		
				
		Schnitt erfolgt durch Federdruck, offener Griff Spring-assisted cutting action, open handle	11 Charr. / Fr. grün / green	
AUT090-027-187	ARS100-027-187	ARS150-011-187		



Arbeitselement für pediatische Resektoskope
Working Element for pediatric Resectoscopes

11 – 13 Charr. / Fr.



Arbeitselement, passiv schneidend / Working Element, passive cutting action



Schnitt erfolgt durch Federdruck, offener Griff
Spring-assisted cutting action, open handle

ARS100-027-187



Elektroden für Kinder-Resektoskope, monopolar

Electrodes for Pediatric Resectoscopes, monopolar

11 – 13 Charr. / Fr.



Schlingenelektrode, abgewinkelt / Cutting Loop electrode, angled		Schlingenelektrode, abgewinkelt, stumpf / Loop electrode, angled, blunt	
11 Charr. / Fr.	13 Charr. / Fr.	11 Charr. / Fr.	13 Charr. / Fr.
ARS150-011-187	ARS150-013-187	ARS152-011-187	ARS152-013-187
Kugelelektrode, gebogen / Ball electrode, curved		Messer-/Nadelelektrode, abgewinkelt / Knife-/Needle electrode, angled	
11 Charr. / Fr.	13 Charr. / Fr.	11 Charr. / Fr.	13 Charr. / Fr.
ARS180-011-187	ARS180-013-187	ARS160-011-187	ARS160-013-187
Hakenelektrode / Hook electrode		Schutzhülse, rostfreier Stahl / Protecting Sleeve, stainless steel	
11 Charr. / Fr.	13 Charr. / Fr.	für die Sterilisation und Aufbewahrung / for sterilization and storage	
ARS170-011-187	ARS170-013-187	AEA030-000-000	

11 Charr. / Fr. = Kennfarbe grün / Colour code green → Endoskope / Endoscopes Ø 2,0 mm







13 Charr. / Fr. = Kennfarbe rot / Colour code red → Endoskope / Endoscopes Ø 2,7 mm



...we can do it!



Hochfrequenz-Kabel, monopolar
High-Frequency Cables, monopolar

instrumentenseitig instrument side	geräteseitig equipment side	Durchmesser Diameter	Länge Length	Bestell-Nr. Ordering number	
		4 mm	3 m	AHC010-040-300	
	Für Geräte von Berchtold, Martin, Aesculap For Berchtold, Martin, Aesculap units				
		4 mm	3 m	AHC012-040-300	
	Für Geräte von Berchtold, Martin, Erbe T-Serie For Berchtold, Martin, Erbe T-Series units				
			5 mm	3 m	AHC014-050-300
	Für Geräte von Erbe ACC/ICC, Storz For Erbe ACC/ICC, Storz units				
		8 mm	3 m	AHC016-080-300	
Für Geräte von Valleylab, Bovie, Conmed For Valleylab, Bovie, Conmed units					

Weitere Kabel auf Anfrage. / Further cables upon request.



Klassisches Urethrotom für Kinder

Classical Urethrotome for children

12 – 24 Charr. / Fr.

Urethrotom nach KEITZER / Urethrotome by KEITZER



bestehend aus: KEITZER OTIS Dilatationsgerät, 2 Messer / consisting of: KEITZER OTIS Dilation device, 2 knives

Bestell-Nr. / Ordering number

60-780-000

KEITZER Ersatzmesser / KEITZER Spare knife

Bestell-Nr. / Ordering number

60-780-001

Auch zur Meatotomie bei Erwachsenen. / Also suitable for Meatotomy at adults.









...we can do it!



Kinder-Urethrotom-Set, Endoskop starr
Pediatric Urethrotome set, Endoscope rigid

13 Charr. / Fr.

Endoskop / Endoscope				
				
Durchmesser Diameter	Blickrichtung Direction of view	Kennfarbe Colour code	Nutzlänge Working length	Bestell-Nr. Ordering number
	0°	grün / green	187,5 mm	AER140-027-000
Schaft mit 2 drehbaren Hähnen inkl. Standardobturator / Sheath with 2 rotatable stopcocks incl. Standard Obturator				
				
Charr. Fr.		Kennfarbe Colour code		Bestell-Nr. Ordering number
13		rot / red		AUT010-013-187
Standardobturator / Standard Obturator				
				
13 Charr. / Fr.		rot / red		AUT080-013-187
Endoskopbrücke mit 3 Charr. Instrumentenkanal Endoscope bridge with 3 Fr. instrument channel	Arbeitselement, passiv schneidend Working Element, passive cutting action		Strikturskalpell, gerade Stricture Scalpel, straight	
				
	Schnitt erfolgt durch Federdruck, offener Griff Spring-assisted cutting action, open handle		13 Charr. / Fr.	
AUT090-027-187	ARS100-027-187		rot / red	
			AUT150-013-187	









Kinder Urologie

Pediatric Urology

Kinder-Urethrotom-Set, Endoskop halbstarrr Pediatric Urethrotome set, Endoscope semi-rigid

11 Charr. / Fr.

Endoskop / Endoscope				
				
Durchmesser Diameter	Blickrichtung Direction of view	Kennfarbe Colour code	Nutzlänge Working length	Bestell-Nr. Ordering number
	0°	grün / green	187,5 mm	AES140-020-000
Schaft mit 2 drehbaren Hähnen inkl. Standardobturator / Sheath with 2 rotatable stopcocks incl. Standard Obturator				
				
Charr. Fr.	Kennfarbe Colour code		Bestell-Nr. Ordering number	
11	grün / green		AUT010-011-187	
Standardobturator / Standard Obturator				
				
11 Charr. / Fr.		grün / green		AUT080-011-187
Endoskopbrücke mit 3 Charr. Instrumentenkanal Endoscope bridge with 3 Fr. instrument channel	Arbeitselement, passiv schneidend Working Element, passive cutting action		Strikturskalpell, gerade Stricture Scalpel, straight	
				
	Schnitt erfolgt durch Federdruck, offener Griff Spring-assisted cutting action, open handle		11 Charr. / Fr.	
			grün / green	
AUT090-027-187	ARS100-027-187		AUT150-011-187	



Arbeitselement für pediatische Urethrotome
Working Element for pediatric Urethrotomes

11 – 13 Charr. / Fr.



Arbeitselement, passiv schneidend / Working Element, passive cutting action



Schnitt erfolgt durch Federdruck, offener Griff
Spring-assisted cutting action, open handle

ARS100-027-187



Strikturskalpelle für Kinder-Urethrotom
zum kalten Schneiden von Harnröhrenstrikturen
Stricture Scalpels for Pediatric Urethrotome
for cold cutting of urethral strictures

11 – 13 Charr. / Fr.



gerade / straight *		sichelförmig / sickle-shaped *	
11 Charr. / Fr.	13 Charr. / Fr.	11 Charr. / Fr.	13 Charr. / Fr.
AUT150-011-187	AUT150-013-187	AUT170-011-187	AUT170-013-187
hakenförmig / hook-shaped *		rund / round *	
11 Charr. / Fr.	13 Charr. / Fr.	11 Charr. / Fr.	13 Charr. / Fr.
AUT174-011-187	AUT174-013-187	AUT160-011-187	AUT160-013-187
Schutzhülse, rostfreier Stahl / Protecting Sleeve, stainless steel			
für die Sterilisation und Aufbewahrung / for sterilization and storage		AEA030-000-000	

* Nicht zur Verwendung mit Hochfrequenz-Strom! / Not to be used with high frequency current!

11 Charr. / Fr. = Kennfarbe grün / Colour code green → Endoskope / Endoscopes Ø 2,0 mm

13 Charr. / Fr. = Kennfarbe rot / Colour code red → Endoskope / Endoscopes Ø 2,7 mm











...we can do it!



Basis-Set für Kinder-Cysto-Urethroskopie
Basic set for Pediatric Cysto-Urethroscopy

13 Charr. / Fr.



Artikelbezeichnung Article description	Produkt Product	Bestell-Nr. Ordering number
Komplett-Set Complete Set		ASE280-020-040
Endoskop 2,7 mm / 30°, 187,5 mm Endoscope 2,7 mm / 30°, 187,5 mm		AER140-027-030
Cysto-Urethroskopschaft, 2 starre Hähne, 1 x 3 Charr. Instrumentenkanal inkl. Standardobturator, 13 Charr. Cysto-Urethroscope sheath, 2 fixed stopcocks, 1 x 3 Fr. instrument channel incl. standard obturator, 13 Fr.		ACU010-013-187
Endoskopbrücke Endoscope bridge		ACU100-027-187
Arbeitseinsatz mit Albarran-Hebel Working element with Albarran deflector		ACU120-027-187
Flexible Fremdkörperzange, Alligatormaul, 280 mm, 3 Charr. Flexible foreign body forceps, Alligator jaw, 280 mm, 3 Fr.,		AFF204-210-028
Flexible Probeexcisionszange, 280 mm, 3 Charr. Flexible biopsy forceps, 280 mm, 3 Fr.,		AFF200-210-028
Flexible Knopfelektrode, 450 mm, 3 Charr. Flexible button electrode, 3 Fr., 450 mm		AHI020-410-045
HF-Kabel, monopolar, für ERBE ACC/ICC, STORZ-Geräte HF Cable, monopolar, for ERBE ACC/ICC, STORZ units		AHC014-050-300
Urethrotom nach KEITZER für Kinder (klassisch) Urethrotome by KEITZER for children (classical)		60-780-000



Basis-Set für Kinder-Resektoskopie (TUR)

Basic set for Pediatric Resectoscopy (TUR)

13 Charr. / Fr.



Artikelbezeichnung Article description	Produkt Product	Bestell-Nr. Ordering number
Komplett-Set Complete Set		ASE280-030-040
Endoskop 2,7 mm / 0°, 187,5 mm Endoscope 2,7 mm / 0°, 187,5 mm		AER140-027-000
Resektoskopschaft mit 1 starren Hahn inkl. Standardobturator, 13 Charr. Resectoscopy sheath with 1 fixed stopcock incl. standard obturator, 13 Fr.		ARS010-013-187
Arbeitselement, passiv schneidend Working element, passive cutting action		ARS100-027-187
Schlingenelektrode, abgewinkelt, 13 Charr. Cutting loop electrode, angled, 13 Fr.		ARS150-013-187
Kugelelektrode, gebogen, 13 Charr. Ball electrode, curved, 13 Fr.		ARS180-013-187
Messer-/Nadelelektrode, abgewinkelt, 13 Charr. Knife-/Needle electrode, angled, 13 Fr.		ARS160-013-187
Schutzhülse für Elektroden, rostfreier Stahl Protecting sleeve for electrodes, stainless steel		AEA030-000-000
HF-Kabel, monopolar, für ERBE ACC/ICC, STORZ-Geräte HF Cable, monopolar, for ERBE ACC/ICC, STORZ units		AHC014-050-300
Urethrotom nach KEITZER für Kinder (klassisch) Urethrotome by KEITZER for children (classical)		60-780-000













...we can do it!



Basis-Set für optische Kinder-Urethrotomie
Basic set for optical Pediatric Urethrotomy

13 Charr. / Fr.



Artikelbezeichnung Article description	Produkt Product	Bestell-Nr. Ordering number
Komplett-Set Complete Set		ASE280-040-040
Endoskop 2,7 mm / 0°, 187,5 mm Endoscope 2,7 mm / 0°, 187,5 mm		AER140-027-000
Urethrotomschaft inkl. Standardobturator, 13 Charr. Urethrotome sheath incl. standard obturator, 13 Fr.		AUT010-013-187
Endoskopbrücke mit 1 x 3 Charr. Instrumentenkanal Endoscope bridge with 1 x 3 Fr. instrument channel		AUT090-027-187
Arbeitselement, passiv schneidend Working element, passive cutting action		ARS100-027-187
Strikturskalpell, gerade, 13 Charr. Stricture scalpel, straight, 13 Fr.		AUT150-013-187
Strikturskalpell, rund, 13 Charr. Stricture scalpel, round, 13 Fr.		AUT160-013-187
Strikturskalpell, sichelförmig, 13 Charr. Stricture scalpel, sickle-shaped, 13 Fr.		AUT170-013-187
Strikturskalpell, hakenförmig, 13 Charr. Stricture scalpel, hook-shaped, 13 Fr.		AUT174-013-187
Schutzhülse für Strikturskalpelle, rostfreier Stahl Protecting sleeve for stricture scalpels, stainless steel		AEA030-000-000
Urethrotom nach KEITZER für Kinder (klassisch) Urethrotome by KEITZER for children (classical)		60-780-000

Notizen

Notes

Instrumente
Instruments

A-line
endoscopy



UROLOGY



...we can do it!



Metallkatheter und Einführungsinstrumente
Metal catheters and introducing instruments

Metallkatheter für Männer / Metal catheters for men

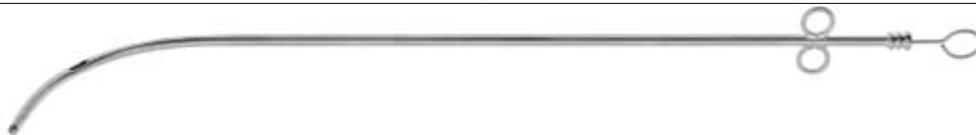



Charr. / Fr.	Bestell-Nr. / Ordering number
8	60-421-008
10	60-421-010
12	60-421-012
14	60-421-014
16	60-421-016
18	60-421-018
20	60-421-020
22	60-421-022
24	60-421-024

Metallkatheter für Frauen / Metal catheters for women



8	60-441-008
10	60-441-010
12	60-441-012
14	60-441-014
16	60-441-016
18	60-441-018
20	60-441-020
22	60-441-022
24	60-441-024

GUYON Katheter-Einführungsinstrument / GUYON Catheter Introducing Instrument

Länge / Length	Bestell-Nr. / Ordering number
gerade / straight	
	
39 cm	366-180-390
gebogen / curved	
	
35 cm	366-181-350



Dilatationsbougies

Dilating Bougies

VAN BUREN Dilatationsbougie, gebogen / VAN BUREN Dilation bougie, curved



Charr. / Fr.	Länge / Length	Bestell-Nr. / Ordering number
8	275 mm	60-321-008
10		60-321-010
12		60-321-012
14		60-321-014
16		60-321-016
18		60-321-018
20		60-321-020
22		60-321-022
24		60-321-024
26		60-321-026
28		60-321-028
30		60-321-030
32		60-321-032
34		60-321-034
36		60-321-036



...we can do it!



Dilatationsbougies
Dilating Bougies

DITTEL Dilatationsbougie, gerade / DITTEL Dilation bougie, straight



Charr. / Fr.	Länge / Length	Bestell-Nr. / Ordering number
8	220 mm	60-330-008
10		60-330-010
12		60-330-012
14		60-330-014
16		60-330-016
18		60-330-018
20		60-330-020
22		60-330-022
24		60-330-024
26		60-330-026
28		60-330-028
30		60-330-030



Dilatationsbougies

Dilating Bougies

DITTEL Dilatationsbougie, gebogen / DITTEL Dilation bougie, curved





Charr. / Fr.	Länge / Length	Bestell-Nr. / Ordering number
8	345 mm	60-335-008
9		60-335-009
10		60-335-010
11		60-335-011
12		60-335-012
13		60-335-013
14		60-335-014
15		60-335-015
16		60-335-016
17		60-335-017
18		60-335-018
19		60-335-019
20		60-335-020
21		60-335-021
22		60-335-022
23		60-335-023
24		60-335-024
25		60-335-025
26		60-335-026
27		60-335-027
28	60-335-028	
29	60-335-029	
30	60-335-030	



...we can do it!

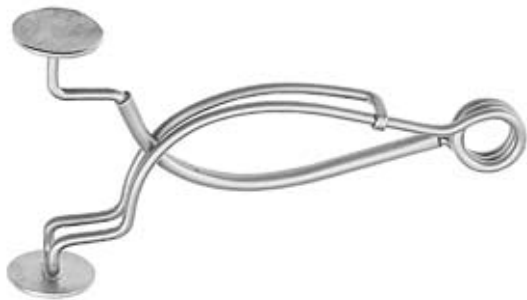

Penisklemmen
Penis Clamps

STOCKMANN		STRAUSS	
			
Länge Length	Bestell-Nr. Ordering number	Länge Length	Bestell-Nr. Ordering number
8 cm	60-821-000	11 cm	60-829-000

Notizen

Notes

Geräte

Equipment

A-line
endoscopy



UROLOGY



...we can do it!



Urologische Rollen-Spülpumpe
Urological Roller Irrigation Pump



Bestell-Nr. / Ordering number: AEU100-000-000

Technische Spezifikationen Technical specifications	
Netzanschluss / Power supply	110 – 240 V AC Netzsicherung / Mains fuse T3, 15 A
Frequenz / Frequency	50 – 60 Hz
Leistungsaufnahme / Power consumption	max. 60 W
Gerätetyp / Device type	BF
Risikoklasse / Safety class	II a
Aufbau / Construction	IN EN 60601-1 (03.96)
Funkentstörung / Radio Interference Suppression	IN EN 60601-1-2 (1993-05)
Spüleleistung / Flow rate	0 – 1.000 ml/min
Druckbereich / Pressure range	10 – 150 mm Hg
Temperaturbereich / Temperature range	+ 10 ... + 40 °C
Luftfeuchtigkeit / Humidity	30 – 70 %
Spritzwasserschutz / Splash water protection	IPX 1
CE Kennzeichnung / CE marking	CE 1253
Abmessungen / Dimensions	380 x 93 x 380 mm (B x H x T) / (w x h x d)
Gewicht / Weight	ca. / approx. 5 kg
Optional / Optional	Computerschnittstelle / Computer interface
Schlauchset / Tubing set	Silikon, autoklavierbar / Silicone, autoclavable



Merkmale / Features:

- ▲ **Pumpe inklusive komplettem Lieferumfang**
Pump including complete scope of delivery
- ▲ **Mikroprozessor gesteuert**
Microprocessor controlled
- ▲ **Weitbereichsnetzteil**
Multi voltage power supply
- ▲ **Bedienerfreundlich**
User friendly
- ▲ **Diverse integrierte Sicherheitsvorkehrungen für einen maximalen Schutz des Patienten**
Several integrated safety arrangements for a maximum protection of the patient
- ▲ **Integriertes Überdrucksicherheitssystem**
Integrated overpressure safety system
- ▲ **Sterilisierbare Druckmesskammer**
Sterilizable pressure measuring chamber

Standardgemäßer Lieferumfang: Standard scope of delivery:

- 1 x Gerät
- 1 x Device
- 1 x Prüfprotokoll
- 1 x Test protocol
- 1 x Bedienungsanleitung
- 1 x Operating instructions
- 1 x Silikon-Schlauchset, komplett
- 1 x Silicon tubing set, complete
- 1 x Netzkabel Euro 2 m
- 1 x Mains cable Euro 2 m
- 2 x Ersatzsicherungen
- 2 x Spare fuses

Zubehör / Accessories:

- ▲ **APA120-000-010:**
Silikon-Schlauchset komplett inkl. Druckmesskammer, Einstechdorn, autoklavierbar
Silicon tubing set complete incl. pressure measuring chamber, piercing thorn, autoclavable
- ▲ **APA120-000-020:**
Silikon-Ablaufschlauch, autoklavierbar
Silicone outflow tubing, autoclavable
- ▲ **APA120-000-030:**
Druckmesskammer alleine, autoklavierbar (10 Stück)
Pressure measuring chamber only, autoclavable (10 pcs.)
- ▲ **APA120-000-040:**
Membranschutz alleine
Membrane protection only
- ▲ **APA120-000-050:**
Einstechdorn alleine
Piercing thorn only
- ▲ **APA120-000-110:**
PVC-Schlauchset komplett, steril verpackt, zum Einmalgebrauch (10 Stück)
PVC-tubing set complete, sterile packed, disposable (10 pcs.)
- ▲ **APA120-000-200:**
Netzkabel Euro 2 m
Mains cable Euro 2 m
- ▲ **APA120-000-210:**
Sicherungen (10 Stück)
Fuses (10 pcs.)

Für weitere Endo-Geräte → bitte unseren separaten Flyer anfordern!
For further Endo Systems → please ask for our separate Flyer!

Zubehör

Accessories

A-line
endoscopy





UROLOGY



...we can do it!





Sterilisations- und Aufbewahrungszubehör
Sterilizing and Storage Accessories

Schutzhülse für Endoskope / Protecting Sleeve for Endoscopes	Für Endoskop-Ø in mm For Endoscope-Ø in mm	Abmessung in mm (L x B x H) Dimensions in mm (l x w x h)	Material Material	Bestell-Nr. Ordering number
	≤ 5		Kunststoff plastic	AEA020-000-000
Schutzhülse für die Sterilisation und Aufbewahrung von Elektroden, Küretten und Skalpellern <i>Protecting sleeve for the sterilization and storage of Electrodes, Curettes and Scalpels</i>				
			rostfreier Stahl stainless steel	AEA030-000-000
Siebkorb für 1 Endoskop / Wire basket for one Endoscope				
	1,0 – 10,0	290 x 80 x 52	rostfreier Stahl stainless steel	74-600-030
		460 x 80 x 52		74-600-040
		670 x 80 x 52		74-600-070
Siebkorb für 2 Endoskope / Wire basket for two Endoscopes				
	1,0 – 10,0	290 x 80 x 52	rostfreier Stahl stainless steel	74-600-050
		460 x 80 x 52		74-600-060
Siebkorb für 1 Endoskop, Lichtleitkabel, inkl. Kleinteilekorb / Wire basket for 1 Endoscope, Cold Light Cable, incl. basket for small parts				
	1,0 – 10,0	640 x 150 x 77	rostfreier Stahl stainless steel	74-600-080



Schlauchverbinder

Tubing Connectors

LUER-LOCK-SCHLAUCHVERBINDER LUER-LOCK TUBING CONNECTOR		LUER-LOCK-SCHLAUCHVERBINDER mit Hahn LUER-LOCK TUBING CONNECTOR with Stopcock	
			
Bohrungs - Ø Bore - Ø	Bestell-Nr. Ordering number	Bohrungs - Ø Bore - Ø	Bestell-Nr. Ordering number
3,0 mm	AEA100-030-000	3,0 mm	AEA110-030-000



...we can do it!



Gummikappe
Rubber Cap

Gummikappe / Rubber Cap	
	
	Bestell-Nr. Ordering number
für Instrumentenkanal / for instrument channel	AEA010-010-000

Pflegeprodukte

Maintenance Products

A-line
endoscopy





UROLOGY



...we can do it!



Pflegemittel für Instrumente
Detergents for Instruments

Instrumentenmilch / Instrument milk		Öl-Spray / Oil-Spray	
			
Liter Litre	Bestell-Nr. Ordering number	Liter Litre	Bestell-Nr. Ordering number
1,0	79-120-100	0,4	79-130-040
5,0	79-120-500		
<p>Unser Flüssigkeitskonzentrat (Mischungsverhältnis mit Wasser 1:20) und Öl-Spray eignen sich hervorragend zur wirksamen Pflege von Chirurgie- und Dentalinstrumenten.</p> <p>Regelmäßige Anwendung gewährleistet eine ausgezeichnete Schmierung der beweglichen Teile und schützt darüberhinaus gegen Korrosion und Oxidation.</p> <p>Die Pflegemittel enthalten keine Silikonbestandteile; sie bilden keine Flecken oder Krusten und sind wasserlöslich.</p> <p>Flüssigkeitskonzentrat und Öl-Spray sind keine Desinfektions- oder Reinigungslösungen, sondern Pflege-, Gleit- und Rostschutzmittel und sind vor der Sterilisation anzuwenden.</p>		<p>Our liquid concentrate (mixture ratio with water 1:20) and oil-spray are excellent aids for the efficient maintenance of surgical and dental instruments.</p> <p>Regular application ensures a perfect lubrication of all the moving parts and protects at the same time against corrosion an oxidation.</p> <p>The preservative agents do not contain silicone constituents; they do not form stains or deposits and are water-soluble.</p> <p>Liquid concentrate and oil-spray are not cleaning or disinfecting solutions; they are means for maintenance, lubrication, and protection against oxidation and should always be applied before sterilization.</p>	



Pflegemittel für Instrumente
Detergents for Instruments

Silikon-Spray / Silicone-Spray



Liter
Litre

Bestell-Nr.
Ordering number

0,5

79-132-050



...we can do it!

Wichtige Hinweise

Important Notices

Wir sind ständig darum bemüht, die in unseren Katalogen präsentierten Produkte zu verbessern und die wachsenden Bedürfnisse unserer Kunden mit den technischen Möglichkeiten eines modernen Produktionsbetriebes zu vereinbaren. Wir behalten uns daher das Recht vor, unsere Produkte ohne vorherige Ankündigung in modifizierter Form auszuliefern.

We are continuously endeavoring to improve the products presented in our catalogues and to combine the increasing requirements of our customers with the technical possibilities of a progressing production plant. We therefore reserve the right to deliver modified products without prior notice.

Dieser Katalog bleibt Eigentum der Firma allgaier instrumente GmbH, auch wenn dafür eine Schutzgebühr bezahlt wurde. Er kann von uns jederzeit zurückgefordert werden, wenn er gegen unsere Interessen und nicht zum Vertrieb und Einkauf von Allgaier Produkten verwendet wird. Auch behalten wir uns in solch einem Falle weitergehende Maßnahmen vor. Der Nachdruck oder das Kopieren dieses Kataloges – im Gesamten oder auch nur auszugsweise – ist ohne unsere schriftliche Genehmigung verboten. Modelländerungen vorbehalten.

This catalogue remains property of allgaier instrumente GmbH even if we have received a nominal fee. We can at any time recall the catalogue, in the case that it has not been used according to our interests, i. e. sale or purchase of Allgaier products. We reserve the right for further action in that case. Reproduction or copying of this catalogue entirely or partially is not allowed without our written permission. Patterns are subject to change.

Sollten Sie Interesse an weiteren endoskopischen Anwendungen/Instrumenten und/oder Geräten haben so kontaktieren Sie uns bitte umgehend!

If you are interested in any further endoscopic applications/instruments and/or units please feel free to contact us promptly!

Inhaltsverzeichnis

Index

A-line
endoscopy



UROLOGY



...we can do it!



Alphabetisch D

Endoskope und Kaltlichtkabel / -Adapter 4 – 13

Technische Merkmale 7

Endoskope, starr, 2,7 – 4,0 mm 8

Endoskope, halbstarr, 2,0 mm 8

Uretero-Renoskope, halbstarr, 6,0 – 7,5 Charr. 9

Uretero-Renoskope, HD, halbstarr, 6,0 – 12 Charr. 10

Perkutane Nephroskope, starr, 24 – 26 Charr. 11

Kaltlichtkabel, HTT 12

Adapter für Kaltlichtkabel 13

Cysto-Urethroskopie 14 – 30

Cysto-Urethroskop-Sets, 17 – 25 Charr. 16

Endoskope
Schäfte mit 2 starren Hähnen inkl. Standardobturator
Endoskopbrücken
Arbeitseinsatz mit Albarran-Lenkhebel

Obturatoren 17 – 25 Charr. 17

Standardobturatoren
Sichtobturatoren

Optische Instrumente, 19 – 25 Charr. 18

Probeexzisionszange, doppelbeweglich
Fasszange, doppelbeweglich
Probeexzisionszange, doppelbeweglich, durchschneidend
Schere, doppelbeweglich
Adapter für optische Instrumente

Optische Steinzange, 25 Charr. 19

Steinzange
Adapter für den Einsatz mit Resektoskopschäften 26 – 28,5 Charr.

Optisches Steinzangen Set 20

Arbeitselement / Optische Steinzange für Endoskope, 12°, 30° (QUICK LOCK)
Schaft mit Zentralhahn, für optische Steinzange (QUICK LOCK)
Schaft mit starrem Hahn, für optische Steinzange (QUICK LOCK)
Standardobturator (QUICK LOCK)
Schafteinsatz mit 7 Charr. Instrumentenkanal (QUICK LOCK)

Cysto-Urethroskop-Set, 15 Charr. 21

Endoskope
Schaft mit 2 starren Hähnen inkl. Standardobturator
Standardobturator

Cysto-Urethroskop-Set, 15 Charr. 22

Endoskope
Schaft mit 2 starren Hähnen inkl. Standardobturator (QUICK LOCK)
Endoskopbrücken (QUICK LOCK)
Arbeitseinsatz mit Albarran-Lenkhebel (QUICK LOCK)

Obturator für Cysto-Urethroskopschaft, 15 Charr. 23

Standardobturator (QUICK LOCK)

Cysto-Urethroskop-Adapter und Gummikappe 24

Zangen, flexibel, isoliert und halbstarr 25

Fremdkörperzangen, Alligatormaul, doppelbeweglich
Probeexzisions- und Fasszangen, oval, gezahnt, doppelbeweglich
Fasszange für Steinstrasse, doppelbeweglich
Probeexzisionszangen, oval, doppelbeweglich

Zangen, flexibel, isoliert und halbstarr 26

Scheren, einfachbeweglich
Hakenscheren, einfachbeweglich
Schere, doppelbeweglich

Flexible Steinfänger und Diathermie-Schlingen 27

Steinfänger
Griff alleine für Steinfänger
Diathermieschlingen
Griff alleine, mit HF-Anschluss für Diathermieschlinge

Flexible Elektroden, monopolar 28

Nadelelektroden
Knopfelektroden
Schlingenelektroden

Hochfrequenz-Kabel, monopolar 29

Basis-Set für Cysto-Urethroskopie, 21 Charr. 30



Alphabetisch D

Resektoskopie	32 – 48	Kleinkalibriges Resektoskop-Set, 19 Charr.	40
Resektoskop-Sets, 24 – 27 Charr.	34	Endoskop	
Endoskop		Resektoskopschaft mit starrem Hahn	
Resektoskopschäfte mit starren Hähnen		Standardobturator	
Standardobturatoren		Arbeitselement, passiv schneidend	
Arbeitselement, passiv schneidend		Schlingenelektrode, abgewinkelt, 30° rückwärts	
Schlingenelektrode, abgewinkelt, 30° rückwärts		Kleinkalibriges Resektoskop-Set, drehbar, 22 Charr.	41
Resektoskop-Sets, feststehend, 26 – 28,5 Charr.	35	Endoskope	
Endoskop		Standardobturator	
Innenschäfte (QUICK LOCK)		Innenschaft (QUICK LOCK)	
Standardobturatoren		Außenschaft mit 2 starren Hähnen (QUICK LOCK)	
Außenschäfte mit 2 starren Hähnen (QUICK LOCK)		Arbeitselement, passiv schneidend	
Arbeitselement, passiv schneidend		Schlingenelektrode, abgewinkelt, 30° rückwärts	
Schlingenelektrode, abgewinkelt, 30° rückwärts		Obturatoren, 19 – 22 Charr.	42
Resektoskop-Sets, drehbar, 26 – 28,5 Charr.	36	Standardobturator	
Endoskop		Sichtobturator	
Innenschäfte (QUICK LOCK)		Arbeitselemente, 19 – 22 Charr.	43
Standardobturatoren		Arbeitselemente, passiv schneidend	
Außenschäfte mit 2 starren Hähnen (QUICK LOCK)		Arbeitselemente, aktiv schneidend	
Arbeitselement, passiv schneidend		Elektroden, monopolar, 19 – 22 Charr.	44
Schlingenelektrode, abgewinkelt, 30° rückwärts		Schlingenelektrode, abgewinkelt, 30° rückwärts	
Obturatoren, 24 – 28,5 Charr.	37	Schlingenelektrode, gerade	
Standardobturatoren		Messerelektrode, abgewinkelt	
Bewegliche Obturatoren		Kugelelektroden	
Sichtobturatoren		Rollenelektroden, glatt	
Sichtobturatoren mit Instrumentenkanal		Schutzhülse, rostfreier Stahl	
Arbeitselemente, 24 – 28,5 Charr.	38	Hochfrequenz-Kabel, monopolar	45
Arbeitselemente, passiv schneidend		Evakuator und Blasenspritzen	46
Arbeitselemente, aktiv schneidend		Evakuator	
Elektroden, monopolar, 24 – 28,5 Charr.	39	Schaftanschluß mit Verriegelung, alleine	
Schlingenelektroden, abgewinkelt, 30° rückwärts		Schaftanschluß mit Konus, alleine	
Schlingenelektroden, abgewinkelt		Blasenspritzen mit Adapter	
Schlingenelektrode, gerade		Basis-Set für Resektoskopie (TUR): 26 Charr.	47
Messerelektroden, abgewinkelt		Basis-Set für Resektoskopie (TUR): 22 Charr.	48
Bandelektroden, abgewinkelt			
Bandelektroden, abgewinkelt, 30° rückwärts			
Küretten, scharf (nicht zur Verwendung mit HF)			
Kugelelektroden			
Rollenelektroden, glatt			
Vaporisationselektroden, glatt			
Kegelelektrode, abgewinkelt			
Schutzhülse, rostfreier Stahl			



Alphabetisch D	
Laseranwendungen	50 – 57
Laser-Cysto-Urethroskop-Set – Dauerspülung	52
Endoskop	
Laser-Cysto-Urethroskopschaft mit 2 starren Hähnen (QUICK LOCK)	
Untersuchungseinsatz mit 8 Charr. Instrumentenkanal (QUICK LOCK)	
Obturatoren für Laser-Cysto-Urethroskopschaft	53
Standardobturator (QUICK LOCK)	
Sichtobturator (QUICK LOCK)	
Laser-Resektoskop-Sets – Dauerspülung, feststehend	54
Endoskope	
Innenschäfte (QUICK LOCK)	
Standardobturatoren	
Außenschäfte mit 2 starren Hähnen (QUICK LOCK)	
Arbeitselement, passiv schneidend	
Laser-Resektoskop-Sets – Dauerspülung, drehbar	55
Endoskope	
Innenschäfte (QUICK LOCK)	
Standardobturatoren	
Außenschäfte mit 2 starren Hähnen (QUICK LOCK)	
Arbeitselement, passiv schneidend	
Arbeitselemente	56
Arbeitselemente, passiv schneidend	
Endoskopbrücke	
Optische Gewebestanze	57
Urethrotomie	58 – 69
Klassisches Urethrotom für Erwachsene, 15 – 45 Charr.	60
Urethrotom nach OTIS – Nutzlänge 200 mm	
OTIS Ersatzmesser	
Klassisches Urethrotom für Kinder, 12 – 24 Charr.	60
Urethrotom nach KEITZER – Nutzlänge 200 mm	
KEITZER Ersatzmesser	
Optisches Urethrotom-Set, 21 Charr.	61
Endoskop	
Urethrotomschaft mit 2 starren Hähnen	
Standardobturator	
Endoskopbrücke	
Arbeitselement, passiv schneidend	
Strikturskalpell	
Obturatoren, Schäfte und Gummikappe	62
Standardobturator	
Obturator mit Instrumentenkanal	
Sichtobturator	
Führungsrohr für Urethrotomschaft	
Urethrotom-Zusatzschaft für Dauerspülung	
Gummikappe	
Arbeitselemente, 21 Charr.	63
Arbeitselemente, passiv schneidend	
Strikturskalpelle, 21 Charr.	64
gerade	
gerade, Wellenschliff	
rund	
sichelförmig	
ringförmig	
Schutzhülse, rostfreier Stahl	
Optisches Urethrotom-Set, 17 Charr.	65
Endoskop	
Urethrotomschaft mit 2 starren Hähnen	
Standardobturator	
Endoskopbrücke	
Arbeitselement, passiv schneidend	
Strikturskalpell	
Obturator, Schaft, Gummikappe, 17 Charr.	66
Standardobturator	
Führungsrohr für Urethrotomschaft	
Gummikappe	
Arbeitselemente für Urethrotom, 17 Charr.	67
Arbeitselemente, passiv schneidend	
Strikturskalpelle für Urethrotom, 17 Charr.	68
gerade	
gerade, Wellenschliff	
rund	
sichelförmig	
Schutzhülse, rostfreier Stahl	
Basis-Set für optische Urethrotomie, 21 Charr.	69



Alphabetisch D	
Uretero-Renoskopie	70 – 79
Uretero-Renoskope, halbstarr, 6,0 – 7,5 Charr.	72
Führungsadapter für Lithotripsie-Handstück	
Gummikappe für Instrumentenkanal	
Flexible Reinigungsbürsten	
Uretero-Renoskope, HD, halbstarr, 6,0 – 12 Charr.	73
Zangen, flexibel, isoliert und halbstarr	74
Fremdkörperzangen, Alligatormaul, doppelbeweglich	
Probeexzisions- und Faszange, oval, gezahnt, doppelbeweglich	
Faszange für Steinstrasse, doppelbeweglich	
Probeexzisionszangen, oval, doppelbeweglich	
Schere, flexibel, einfachbeweglich	
Flexible Steinfänger	75
Steinfänger	
Griff alleine für Steinfänger	
Flexible Elektroden, monopolar	76
Nadelelektroden	
Knopfelektroden	
Schlingenelektroden	
Hochfrequenz-Kabel, monopolar	77
Basis-Set für Uretero-Renoskopie, halbstarr, 7,5 Charr.	78
Basis-Set für Uretero-Renoskopie, HD, halbstarr, 7,5-12 Charr.	79
Perkutane Nephroskopie	80 – 87
Perkutane Nephroskope, 24 – 26 Charr.	82
Perkutane Nephroskope, Durchmesser 7,4 x 4,5 mm	
Adapter mit Hahn	
Dichtungskappe	
Schäfte und Obturatoren, 24 – 26 Charr.	83
Nephroskopschäfte mit drehbarem Hahn	
Obturatoren (hohl)	
Teleskop-Dilatatoren und Reinigungsbürsten	84
Teleskop-Dilatator-Set bestehend aus 6 Dilatatoren	
Weitere Dilatatoren (Hülsen)	
Führungssonden, allein	
Reinigungsbürsten	
Instrumente	85
Faszange für Biopsie, Löffel oval, einseitig öffnend	
Faszange für Steinfragmente, gefenstert, doppelbeweglich	
Faszange für Steinfragmente, doppelbeweglich, Hechtmaul	
Mikroschere, gerade, einseitig öffnend	
Dreigreifer für grössere Steinfragmente, U-Federgriff	
Basis-Set für perkutane Nephroskopie, 26 Charr.	86
Kinder Urologie	88 – 109
Kinder-Cysto-Urethroskop-Set, 13 Charr.	90
Endoskope	
Schaft mit 2 starren Hähnen, 1 instr.-Kanal	
Standardobturator	
Endoskopbrücke	
Arbeitseinsatz mit ALBARRAN-Lenkhebel	
Kinder-Cysto-Urethroskop-Set, 11 Charr.	91
Endoskope	
Schaft mit 2 starren Hähnen, 1 instr.-Kanal	
Standardobturator	
Kinder-Cysto-Urethroskop-Set, 9,5 Charr.	92
Endoskope	
Schaft mit 2 starren Hähnen, 1 instr.-Kanal	
Standardobturator	
Zangen, flexibel, isoliert und halbstarr	93
Fremdkörperzangen, Alligatormaul, doppelbeweglich	
Probeexzisions- und Faszange, oval, gezahnt, doppelbeweglich	
Probeexzisionszangen, oval, doppelbeweglich	
Schere, einfachbeweglich	
Flexible Elektroden, monopolar	94
Nadelelektroden	
Knopfelektroden	
Schlingenelektroden	
Hochfrequenz-Kabel, monopolar	95



Alphabetisch D

Kinder-Resektoskop-Set, 13 Charr. 96
 Endoskop
 Schaft mit 1 drehbaren Hahn
 Standardobturator
 Endoskopbrücke mit 3 Charr. Instrumentenkanal
 Arbeitselement, passiv schneidend
 Schlingenelektrode, abgewinkelt

Kinder-Resektoskop-Set, 11 Charr. 97
 Endoskop
 Schaft mit 1 drehbaren Hahn
 Standardobturator
 Endoskopbrücke mit Instrumentenkanal, 3 Charr.
 Arbeitselement, passiv schneidend
 Schlingenelektrode, abgewinkelt

Arbeitselement, 11 – 13 Charr. 98
 Arbeitselement, passiv schneidend

Elektroden, monopolar, 11 – 13 Charr. 99
 Schlingenelektroden, abgewinkelt
 Schlingenelektroden, abgewinkelt, stumpf
 Kugelelektroden, gebogen
 Nadelelektroden
 Hakenelektroden
 Schutzhülse, rostfreier Stahl

Hochfrequenz-Kabel, monopolar 100

Klassisches Urethrotom für Kinder, 12 – 24 Charr. 101
 Urethrotom nach KEITZER
 KEITZER Ersatzmesser

Kinder-Urethrotom-Set, 13 Charr. 102
 Endoskop
 Schaft mit 2 drehbaren Hähnen
 Standardobturator
 Endoskopbrücke mit Instrumentenkanal, 3 Charr.
 Arbeitselement, passiv schneidend
 Strikturskalpell, gerade

Kinder-Urethrotom-Set, 11 Charr. 103
 Endoskop
 Schaft mit 2 drehbaren Hähnen
 Standardobturator
 Endoskopbrücke mit Instrumentenkanal, 3 Charr.
 Arbeitselement, passiv schneidend
 Strikturskalpell, gerade

Arbeitselement, 11 – 13 Charr. 104
 Arbeitselement, passiv schneidend

Strikturskalpelle, 11 – 13 Charr. 105
 gerade
 sichelförmig
 hakenförmig
 rund
 Schutzhülse, rostfreier Stahl

Basis-Set für Kinder-Cysto-Urethroskopie, 13 Charr. 106

Basis-Set für Kinder-Resektoskopie (TUR), 13 Charr. 107

Basis-Set für optische Kinder-Urethrotomie, 13 Charr. 108

Instrumente 110 – 117

Metallkatheter und Einführungsinstrumente 112
 Metallkatheter für Männer
 Metallkatheter für Frauen
 GUYON Katheter-Einführungsinstrumente

Dilatationsbougies 113
 VAN BUREN Dilatationsbougies, gebogen

Dilatationsbougies 114
 DITTEL Dilatationsbougies, gerade

Dilatationsbougies 115
 DITTEL Dilatationsbougies, gebogen

Penisklemmen 116
 STOCKMANN
 STRAUSS

Geräte 118 – 121

Urologische Rollen-Spülpumpe 120
 Technische Spezifikationen
 Merkmale
 Zubehör
 Lieferumfang



Alphabetisch D	
Zubehör	122 – 127
Sterilisations- und Aufbewahrungszubehör	124
Schutzhülse für Endoskope	
Schutzhülse für Elektroden, Küretten und Skalpelle	
Siebkörbe für 1 Endoskop	
Siebkörbe für 2 Endoskope	
Siebkörbe für 1 Endoskop, Lichtleitkabel, inkl. Kleinteilekorb	
Schlauchverbinder	125
LUER-LOCK-SCHLAUCHVERBINDER	
LUER-LOCK-SCHLAUCHVERBINDER mit Hahn	
Gummikappe	126
Pflegeprodukte	128 – 131
Pflegemittel für Instrumente	130
Instrumentenmilch	
Öl-Spray	
Silikon-Spray	131
Sets	20 – 108
Optische Steinzangen	20
Cysto-Urethroskop-Set, 15 Charr.	21, 22
Cysto-Urethroskopie, 21 Charr.	30
Resektoskopie (TUR), 26 Charr.	47
Resektoskopie (TUR), 22 Charr.	48
Urethrotomie, 21 Charr.	69
Basis-Set für Uretero-Renoskopie, halbstarr, 7,5 Charr.	78
Basis-Set für Uretero-Renoskopie, HD, halbstarr, 7,5-12 Charr. ..	79
Perkutane Nephroskopie, 26 Charr.	86
Kinder-Cysto-Urethroskopie, 13 Charr.	106
Kinder-Resektoskopie (TUR), 13 Charr.	107
Kinder-Urethrotomie, 13 Charr.	108



Alphabetical GB	
Endoscopes and Cold Light Cables / Adaptors 4 – 13	
Technical Features 7	
Endoscopes, rigid, 2,7 – 4,0 mm 8	
Endoscopes, semi-rigid, 2,0 mm 8	
Uretero-Renoscopes, semi-rigid, 6,0 – 7,5 Fr. 9	
Uretero-Renoscopes, HD, semi-rigid , 6,0 – 12 Charr. 10	
Percutaneous Nephroscopes, rigid, 24 – 26 Fr. 11	
Cold Light Cables, HTT 12	
Adaptors for Cold Light Cables 13	
<hr/>	
Cysto-Urethroscopy 14 – 30	
Cysto-Urethroscope-set, 17 – 25 Fr. 16	
Endoscopes	
Sheaths with 2 fixed stopcocks incl. Standard Obturator	
Endoscope Bridges	
Working element with Albarran deflector	
Obturers, 17 – 25 Fr. 17	
Standard Obturers	
Viewing Obturers	
Optical Instruments, 19 – 25 Fr. 18	
Biopsy forceps, double action	
Grasping forceps, double action	
Biopsy forceps, double action, through cutting	
Scissors, double action	
Adaptor for optical instruments	
Optical Stone Forceps, 25 Fr. 19	
Stone crushing forceps	
Adaptor for use with resectoscope sheaths 26 – 28.5 Fr.	
Optical Stone crushing set 20	
Working element / Stone crushing forceps for endoscopes, 12°, 30° (QUICK LOCK)	
Sheath with central valve, for optical stone crushing forceps (QUICK LOCK)	
Sheath with fixed stopcock, for optical stone crushing forceps (QUICK LOCK)	
Standard Obturator (QUICK LOCK)	
Sheath insert with 7 Fr. instrument channel (QUICK LOCK)	
Cysto-Urethroscope-Set 15 Fr. 21	
Endoscopes	
Sheath with 2 fixed stopcocks incl. Standard Obturator	
Standard Obturator	
Cysto-Urethroscope sets , 15 Fr. 22	
Endoscopes	
Sheath with 2 fixed stopcocks incl. Standard Obturator (QUICK LOCK)	
Endoscope Bridges (QUICK LOCK)	
Working element with Albarran Deflector (QUICK LOCK)	
Obturator for Cysto-Urethroscope sheath, 15 Fr. 23	
Standard Obturator (QUICK LOCK)	
Cysto-Urethroscope-Adaptor and Rubber Cap 24	
Forceps, flexible, insulated and semi-rigid 25	
Foreign body forceps, alligator jaw, double action	
Biopsy and grasping forceps, oval, serrated, double action	
Grasping forceps for large stone fragments, double action	
Biopsy forceps, oval, double action	
Forceps, flexible, insulated and semi-rigid 26	
Scissors, single action	
Hook scissors, single action	
Scissors, double action	
Flexible Stone Extractors and Diathermy Loops 27	
Stone Extractor	
Handle only for Stone Extractor	
Diathermy Loops	
Handle only, with HF-Connection for Diathermy Loop	
Flexible Electrodes, monopolar 28	
Needle Electrodes	
Button Electrodes	
Loop Electrodes	
High-Frequency Cables, monopolar 29	
Basic set for Cysto-Urethroscopy, 21 Fr. 30	



Alphabetical GB

Resectoscopy 32 – 49**Resektoscope-Sets, 24 – 27 Fr.** 34

Endoscope

Resectoscope sheaths with fixed stopcocks

Standard Obturators

Working Element, passive cutting action

Loop electrodes, angled, 30° backwards

Resectoscope sets, fixed, 26 – 28,5 Fr. 35

Endoscope

Inner sheaths (QUICK LOCK)

Standard Obturators

Outer sheaths with 2 fixed stopcocks (QUICK LOCK)

Working Element, passive cutting action

Loop electrodes, angled, 30° backwards

Resectoscope sets, rotatable, 26 – 28,5 Fr. 36

Endoscope

Inner sheaths (QUICK LOCK)

Standard Obturators

Outer sheaths with 2 fixed stopcocks (QUICK LOCK)

Working Element, passive cutting action

Loop electrodes, angled, 30° backwards

Obturers, 24 – 28,5 Fr. 37

Standard Obturators

Deflecting Obturators

Viewing Obturators

Viewing Obturators with instrument channel

Working Elements, 24 – 28,5 Fr. 38

Working Elements, passive cutting action

Working Elements, active cutting action

Electrodes, monopolar, 24 – 28,5 Fr. 39

Loop electrodes, angled, 30° backwards

Loop electrodes, angled

Loop electrodes, straight

Knife electrode, angled

Band electrodes, angled

Band electrodes, angled, 30° backwards

Curettes, sharp (not for use with HF)

Rollerball electrodes

Roller electrodes, smooth

Vaporization electrodes, smooth

Conical electrode, angled

Protecting Sleeve, stainless steel

Slim calibre Resectoscope set, 19 Fr. 40

Endoscope

Resectoscope sheath with fixed stopcock

Standard Obturator

Working Element, passive cutting action

Loop electrodes, angled, 30° backwards

Slim calibre Resectoscope set, rotatable, 22 Fr. 41

Endoscopes

Standard Obturator

Inner sheath (QUICK LOCK)

Outer sheath with 2 fixed stopcocks (QUICK LOCK)

Working Element, passive cutting action

Loop electrodes, angled, 30° backwards

Obturers, 19 – 22 Fr. 42

Standard Obturator

Viewing Obturator

Working Elements, 19 – 22 Fr. 43

Working Elements, passive cutting action

Working Elements, active cutting action

Electrodes, monopolar, 19 – 22 Fr. 44

Loop electrodes, angled, 30° backwards

Loop electrodes, straight

Knife electrode, angled

Rollerball electrodes

Roller electrodes, smooth

Protecting Sleeve, stainless steel

High-Frequency Cables, monopolar 45**Evacuator and Bladder Syringes** 46

Evacuator

Sheath connection with locking device, only

Sheath connection with cone, only

Bladder Syringes with adaptor

Basic set for Resectoscopy (TUR): 26 Fr. 47**Basic set for Resectoscopy (TUR): 22 Fr.** 48



Alphabetical GB	
Laser Applications	50 – 57
<hr/>	
Laser Cysto-Urethroscope set – Continuous-Flow	52
Endoscope	
Laser Cysto-Urethroscope sheath with 2 fixed stopcocks (QUICK LOCK)	
Examination insert with 8 Fr. instrument channel (QUICK LOCK)	
Obturers for Laser Cysto-Urethroscope sheath	53
Standard Obturator (QUICK LOCK)	
Viewing Obturator (QUICK LOCK)	
Laser Resectoscope sets with continuous flow double-sheath system, fixed, 26 – 28,5 Charr. / Fr.	54
Endoscopes	
Inner sheaths (QUICK LOCK)	
Standard Obturator	
Outer sheaths with 2 fixed stopcocks (QUICK LOCK)	
Working Element, passive cutting action	
Laser Resectoscope sets with continuous flow double-sheath system, rotatable, 26 – 28,5 Charr. / Fr.	55
Endoscopes	
Inner sheaths (QUICK LOCK)	
Standard Obturator	
Outer sheaths with 2 fixed stopcocks (QUICK LOCK)	
Working Element, passive cutting action	
Working Elements	56
Working Elements, passive cutting action	
Endoscope Bridge	
Optical Tissue Punch	57
<hr/>	
Urethrotomy	58 – 69
<hr/>	
Classical Urethrotome for adults, 15 – 45 Fr.	60
Urethrotome by OTIS – Working length 200 mm	
OTIS Spare Knife	
Classical Urethrotome for children, 12 – 24 Fr.	60
Urethrotome by KEITZER – Working length 200 mm	
KEITZER Spare Knife	
Optical Urethrotome set, 21 Fr.	61
Endoscope	
Urethrotome sheath with 2 fixed stopcocks	
Standard Obturator	
Endoscope Bridge	
Working Element, passive cutting action	
Stricture Scalpel	
Obturers, sheaths and rubber cap	62
Standard Obturator	
Obturator with instrument channel	
Viewing Obturator	
Guide Tube for Urethrotome sheath	
Supplementary Urethrotome sheath for continuous irrigation	
Rubber Cap	
Working Elements, 21 Fr.	63
Working Elements, passive cutting action	
Stricture Scalpels, 21 Fr.	64
straight	
straight, wave-shaped	
round	
sickle-shaped	
ring-shaped	
Protecting Sleeve, stainless steel	
Optical Urethrotome set, 17 Fr.	65
Endoscope	
Urethrotome sheath with 2 fixed stopcocks	
Standard Obturator	
Endoscope Bridge	
Working Element, passive cutting action	
Stricture Scalpel	
Obturers, sheaths and rubber cap, 17 Fr.	66
Standard Obturator	
Guide Tube for Urethrotome sheath	
Rubber Cap	
Working Elements for Urethrotom, 17 Fr.	67
Working Elements, passive cutting action	
Stricture Scalpels for Urethrotom, 17 Fr.	68
straight	
straight, wave-shaped	
round	
sickle-shaped	
Protecting Sleeve, stainless steel	
Basic set for optical Urethrotomy, 21 Fr.	69



Alphabetical GB	
Uretero-Renoscapy	70 – 79
Uretero-Renoscopes, semi-rigid, 6,0 – 7,5 Fr.	72
Guide Adaptor for Lithotripsy handle	
Rubber Cap for instrument channel	
Flexible Cleaning Brushes	
Uretero-Renoscopes, HD, semi-rigid, 6,0 – 12 Fr.	73
Forceps, flexible, insulated and semi-rigid	74
Foreign body forceps, alligator jaw, double action	
Biopsy and grasping forceps, oval, serrated, double action	
Grasping forceps for large stone fragments, double action	
Biopsy forceps, oval, double action	
Scissors, flexible, single action	
Flexible stone extractors	75
Stone Extractor	
Handle only for Stone Extractor	
Flexible Electrodes, monopolar	76
Needle Electrodes	
Button Electrodes	
Loop Electrodes	
High-Frequency Cables, monopolar	77
Basic set for Uretero-Renoscapy, semi-rigid, 7,5 Fr.	78
Basic set for Uretero-Renoscapy, HD, semi-rigid, 7,5 – 12 Fr. ...	79
Percutaneous Nephrosopy	80 – 87
Percutaneous Nephroscopes, 24 – 26 Fr.	82
Diameter 7,4 x 4,5 mm	
Adaptor with stopcock	
Sealing Cap	
Sheaths and Obturators, 24 – 26 Fr.	83
Nephroscope sheaths with rotatable stopcock	
Obturators (hollow)	
Telescope-Dilators and Cleaning Brushes	84
Telescope-Dilator set – standard – consisting of 6 Dilators	
Further Dilators (sleeves)	
Guide probes, only	
Cleaning Brushes	
Instruments	85
Grasping forceps for biopsy, oval spoon, single action	
Grasping forceps for stone fragments, fenestrated, double action	
Grasping forceps for stone fragments, double action, pike jaw	
Micro-scissors, straight, single action	
Threefold grasper for large stone fragments, U-spring handle	
Basic set for percutaneous Nephrosopy, 26 Fr.	86
Pediatric Urology	88 – 109
Pediatric Cysto-Urethroscope set, 13 Fr.	90
Endoscopes	
Sheath with 2 fixed stopcocks, 1 Instr. channel	
Standard Obturator	
Endoscope Bridge	
Working element with ALBARRAN deflector	
Pediatric Cysto-Urethroscope set, 11 Fr.	91
Endoscopes	
Sheath with 2 fixed stopcocks, 1 Instr. channel	
Standard Obturator	
Pediatric Cysto-Urethroscope set, 9,5 Fr.	92
Endoscope	
Sheath with 2 fixed stopcocks, 1 Instr. channel	
Standard Obturator	
Forceps, flexible, insulated and semi-rigid	93
Foreign body forceps, alligator jaw, double action	
Biopsy and grasping forceps, oval, serrated, double action	
Biopsy forceps, oval, double action	
Scissors, single action	
Flexible Electrodes, monopolar	94
Needle Electrodes	
Button Electrodes	
Loop Electrodes	
High-Frequency Cables, monopolar	95



Alphabetical GB	
Pediatric Resectoscope set, 13 Fr.	96
Endoscope	
Sheath with 1 rotatable stopcock	
Standard Obturator	
Endoscope bridge with instrument channel, 3 Fr.	
Working Element, passive cutting action	
Loop electrodes, angled	
Pediatric Resectoscope set, 11 Fr.	97
Endoscope	
Sheath with 1 rotatable stopcock	
Standard Obturator	
Endoscope bridge with instrument channel, 3 Fr.	
Working Element, passive cutting action	
Loop electrodes, angled	
Working Element, 11 – 13 Fr.	98
Working Element, passive cutting action	
Electrodes, monopolar, 11 – 13 Fr.	99
Cutting Loop electrodes, angled	
Loop electrodes, angled, blunt	
Ball electrodes, curved	
Knife-/Needle electrodes, angled	
Hook electrodes	
Protecting Sleeve, stainless steel	
High-Frequency Cables, monopolar	100
Classical Urethrotome for children, 12 – 24 Fr.	101
Urethrotome by KEITZER	
KEITZER Spare knife	
Pediatric Urethrotome set, 13 Fr.	102
Endoscope	
Sheath with 2 rotatable stopcocks	
Standard Obturator	
Endoscope bridge with instrument channel, 3 Fr.	
Working Element, passive cutting action	
Stricture Scalpel, straight	
Pediatric Urethrotome set, 11 Fr.	103
Endoscope	
Sheath with 2 rotatable stopcocks	
Standard Obturator	
Endoscope bridge with instrument channel, 3 Fr.	
Working Element, passive cutting action	
Stricture Scalpel, straight	
Working Element, 11 – 13 Fr.	104
Working Element, passive cutting action	
Stricture Scalpels, 11 – 13 Fr.	105
straight	
sickle-shaped	
hook-shaped	
round	
Protecting Sleeve, stainless steel	
Basic set for Pediatric Cysto-Urethroscopy, 13 Fr.	106
Basic set for Pediatric Resectoscopy (TUR): 13 Fr.	107
Basic set for optical Pediatric Urethrotomy, 13 Fr.	108
<hr/>	
Instruments	110 – 117
<hr/>	
Metal catheters and introducing instruments	112
Metal catheters for men	
Metal catheters for women	
GUYON Catheter Introducing Instruments	
Dilation Bougies	113
VAN BUREN Dilation bougies, curved	
Dilation Bougies	114
DITTEL Dilation bougies, straight	
Dilation Bougies	115
DITTEL Dilation bougies, curved	
Penis Clamps	116
STOCKMANN	
STRAUSS	
<hr/>	
Equipment	118 – 121
<hr/>	
Urological Roller Irrigation Pump	120
Technical specifications	
Features	
Accessories	
Delivery	



Alphabetical GB	
Accessories	122 – 127
Sterilizing and Storage Accessories	124
Protecting Sleeve for endoscopes	
Protecting sleeve for Electrodes, Curettes and Scalpels	
Wire baskets for 1 endoscope	
Wire baskets for 2 endoscopes	
Wire baskets for 1 endoscope, cold light cable, incl. basket for small parts	
Tubing Connectors	125
LUER-LOCK TUBING CONNECTOR	
LUER-LOCK TUBING CONNECTOR with Stopcock	
Rubber Cap	126
Maintenance Products	128 – 131
Detergents for Instruments	130
Instrument milk	
Oil-Spray	
Silicone-Spray	131
Sets	20 – 108
Optical Stone crushing set	20
Cysto-Urethroscope-Set 15 Fr.	21, 22
Cysto-Urethroscopy, 21 Fr.	30
Resectoscopy (TUR), 26 Fr.	47
Resectoscopy (TUR), 22 Fr.	48
Urethrotomy, 21 Fr.	69
Basic set for Uretero-Renoscopia, semi-rigid, 7,5 Fr.	78
Basic set for Uretero-Renoscopia, HD, semi-rigid, 7,5 – 12 Fr. ...	79
Perkutane Nephroscopy, 26 Fr.	86
Pediatric Cysto Urethroscopy, 13 Fr.	106
Pediatric Resectoscopy (TUR), 13 Fr.	107
Pediatric Urethrotomy, 13 Fr.	108



Numerisch / Numerical

366-180-390.....	112	60-335-018.....	115	79-120-500.....	130
366-181-350.....	112	60-335-019.....	115	79-130-040.....	130
418-928-050.....	46	60-335-020.....	115	79-132-05.....	131
418-928-075.....	46	60-335-021.....	115	92-951-035HTT.....	11
418-928-100.....	46, 48	60-335-022.....	115	92-951-048HTT.....	11
418-928-150.....	30, 46, 47, 69	60-335-023.....	115	92-952-035HTT.....	11
418-928-200.....	46	60-335-024.....	115	92-952-048HTT.....	11
60-321-008.....	113	60-335-025.....	115	92-953-035HTT.....	11
60-321-010.....	113	60-335-026.....	115	92-953-048HTT.....	11
60-321-012.....	113	60-335-027.....	115	92-960-002.....	12
60-321-014.....	113	60-335-028.....	115	92-960-004.....	12
60-321-016.....	113	60-335-029.....	115	92-960-006.....	12
60-321-018.....	113	60-335-030.....	115	92-960-008.....	12
60-321-020.....	113	60-421-008.....	112	92-960-010.....	12
60-321-022.....	113	60-421-010.....	112	92-960-012.....	12
60-321-024.....	113	60-421-012.....	112	92-960-014.....	12
60-321-026.....	113	60-421-014.....	112	92-960-018.....	12
60-321-028.....	113	60-421-016.....	112	92-960-022.....	12
60-321-030.....	113	60-421-018.....	112	92-960-024.....	12
60-321-032.....	113	60-421-020.....	112	92-962-002.....	12
60-321-034.....	113	60-421-022.....	112	92-962-004.....	12
60-321-036.....	113	60-421-024.....	112	92-962-008.....	12
60-330-008.....	114	60-441-008.....	112	92-962-020.....	12
60-330-010.....	114	60-441-010.....	112	ACU010-009-187.....	92
60-330-012.....	114	60-441-012.....	112	ACU010-011-187.....	91
60-330-014.....	114	60-441-014.....	112	ACU010-013-187.....	90, 106
60-330-016.....	114	60-441-016.....	112	ACU010-015-302.....	22
60-330-018.....	114	60-441-018.....	112	ACU010-017-302.....	16
60-330-020.....	114	60-441-020.....	112	ACU010-019-302.....	16
60-330-022.....	114	60-441-022.....	112	ACU010-021-302.....	16, 30
60-330-024.....	114	60-441-024.....	112	ACU010-023-302.....	16
60-330-026.....	114	60-780-000.....	60, 101, 106-108	ACU010-025-302.....	16
60-330-028.....	114	60-780-001.....	60, 101	ACU011-015-302.....	21
60-330-030.....	114	60-782-000.....	30, 47, 47, 60, 69	ACU080-009-187.....	92
60-335-008.....	115	60-782-001.....	60	ACU080-011-187.....	91
60-335-009.....	115	60-821-000.....	116	ACU080-013-187.....	90
60-335-010.....	115	60-829-000.....	116	ACU080-015-302.....	23
60-335-011.....	115	74-600-030.....	124	ACU081-015-302.....	21
60-335-012.....	115	74-600-040.....	124	ACU084-017-302.....	17
60-335-013.....	115	74-600-050.....	124	ACU084-019-302.....	17
60-335-014.....	115	74-600-060.....	124	ACU084-021-302.....	17, 30
60-335-015.....	115	74-600-070.....	124	ACU084-023-302.....	17
60-335-016.....	115	74-600-080.....	78, 79, 124	ACU084-025-302.....	17
60-335-017.....	115	79-120-100.....	130	ACU100-027-187.....	90, 106



Numerisch / Numerical

ACU100-029-302	22	AEI106-000-000	46	AFF200-230-040	25
ACU100-040-302	16	AEI110-000-000	46	AFF200-416-028	93
ACU102-029-302	22	AEI112-000-000	46	AFF200-416-040	25
ACU102-040-302	16, 30	AER140-027-000		AFF200-416-060	74
ACU104-029-302	22 7, 90, 91, 96, 102, 107, 108		AFF200-421-040	25
ACU104-040-302	16	AER140-027-030	7, 90, 91, 106	AFF200-423-040	25
ACU120-027-187	90, 106	AER140-027-070	7, 90, 91	AFF200-430-040	25
ACU120-029-302	22	AER150-027-000	7, 21, 22	AFF200-610-028	93
ACU120-040-302	16	AER150-027-030	7, 21, 22	AFF200-610-040	25
ACU124-029-302	22	AER150-027-070	7, 21, 22	AFF200-610-060	74
ACU124-040-302	16, 30	AER150-029-000	7, 21, 22, 65	AFF200-616-028	93
ACU150-040-302	18	AER150-029-030	7, 21, 22, 40, 41, 48	AFF200-616-040	25
ACU152-040-302	18	AER150-029-070	7, 21, 22	AFF200-616-060	74
ACU154-040-302	18	AER300-040-000	7, 16, 61, 69, 54, 55	AFF200-621-040	25
ACU156-040-302	18	AER300-040-012	7, 16, 54, 55	AFF200-623-040	25
ACU160-040-302	18	AER300-040-030		AFF200-630-040	25
ACU170-040-302	18 7, 16, 30, 34-36, 47, 52, 54, 55		AFF201-216-028	93
ACU180-040-302	18	AER300-040-070	7, 16	AFF201-216-040	26, 30
ACU200-040-302	19	AER520-074-000	10, 82	AFF201-216-060	74, 78, 79
ACU202-040-302	19	AER525-074-000	10, 82, 86	AFF201-221-040	26
ACU210-024-302	20	AER530-074-000	10, 82	AFF201-223-040	26
ACU214-024-302	20	AER535-074-000	10, 82	AFF201-230-040	26
ACU220-024-302	20	AES120-060-008	8, 72	AFF201-416-028	93
ACU226-024-302	20	AES130-060-008	8, 72	AFF201-416-040	26
ACU230-040-302	20	AES140-020-000	7, 91, 92, 97, 103	AFF201-416-060	74
ACU310-023-302	52	AES140-020-030	7, 91, 92	AFF201-421-040	26
ACU320-023-302	53	AES140-075-008	8, 72	AFF201-423-040	26
ACU324-023-302	53	AES150-075-008	8, 72, 78	AFF201-430-040	26
ACU326-023-302	52	AES202-030-000	9, 73	AFF201-616-028	93
ACU800-000-000	24	AES204-030-000	9, 73	AFF201-616-040	26
AEA010-010-000	24, 62, 66, 72, 126	AES206-030-000	9, 73	AFF201-616-060	74
AEA020-000-000	124	AES302-040-000	9, 73	AFF201-621-040	26
AEA030-000-000		AES304-040-000	9, 73	AFF201-623-040	26
..... 39, 44, 47, 48, 64, 68, 69,		AES306-040-000	9, 73, 79	AFF201-630-040	26
..... 99, 105, 107, 108, 124		AEU100-000-000	120	AFF202-223-040	26
AEA100-030-000	125	AFF200-210-028	93, 706	AFF202-230-040	26
AEA110-030-000	125	AFF200-210-040	25	AFF202-423-040	26
AEA800-212-060	72	AFF200-210-060	74	AFF202-430-040	26
AEA800-220-060	72	AFF200-216-028	93	AFF202-623-040	26
AEA900-030-000	84	AFF200-216-040	25	AFF202-630-040	26
AEA900-060-000	84	AFF200-216-060	74	AFF203-216-028	93
AEI100-000-000	46-48	AFF200-221-040	25	AFF203-216-040	25
AEI104-000-000	46	AFF200-223-040	25, 30	AFF203-216-060	74, 78





Numerisch / Numerical

AFF203-216-060.....	79	AFF208-616-060.....	74	ALU080-017-302.....	17
AFF203-221-040.....	25	AFI210-016-000.....	27, 30, 75, 78, 79	ALU080-019-302.....	17
AFF203-223-040.....	25	AFI210-023-000.....	27	ALU080-021-302.....	17
AFF203-230-040.....	25	AFI210-208-040.....	27	ALU080-023-302.....	17
AFF203-416-028.....	93	AFI210-208-060.....	75	ALU080-025-302.....	17
AFF203-416-040.....	25	AFI210-210-040.....	27	ANE012-024-200.....	83
AFF203-416-060.....	74	AFI210-210-060.....	75	ANE032-026-200.....	83, 86
AFF203-421-040.....	25	AFI210-216-040.....	27, 30	ANE042-026-250.....	83
AFF203-423-040.....	25	AFI210-216-060.....	75, 78, 79	ANE086-024-200.....	83
AFF203-430-040.....	25	AFI210-216-060.....	79	ANE086-026-200.....	83, 86
AFF203-616-028.....	93	AFI210-223-040.....	27	ANE086-026-250.....	83
AFF203-616-040.....	25	AFI210-416-040.....	27	ANE150-603-042.....	85, 86
AFF203-616-060.....	74	AFI210-416-060.....	75	ANE160-603-042.....	85, 86
AFF203-621-040.....	25	AFI210-423-040.....	27	ANE164-603-042.....	85, 86
AFF203-623-040.....	25	AFI210-616-040.....	27	ANE170-603-042.....	85, 86
AFF203-630-040.....	25	AFI210-616-060.....	75	ANE180-603-042.....	85, 86
AFF204-210-028.....	93, 93	AFI210-623-040.....	27	ANE200-024-000.....	84, 76
AFF204-210-040.....	25, 74	AHC010-040-300.....	29, 45, 77, 95, 100	ANE204-027-000.....	84
AFF204-216-028.....	93	AHC012-040-300.....	29, 45, 77, 95, 100	ANE204-030-000.....	84
AFF204-216-040.....	25, 30	AHC014-050-300.....	ANE210-000-000.....	84
AFF204-216-060.....	74, 78, 79	29, 30, 45, 47, 48, 77, 95, 100, 106, 107	ANE214-000-000.....	84
AFF204-223-040.....	25	AHC016-080-300.....	29, 45, 77, 95, 100	ANE810-050-000.....	82
AFF204-230-040.....	25	AHI010-410-045.....	28, 76, 94	ANE810-050-000.....	86
AFF204-416-028.....	93	AHI010-410-065.....	76	ANE830-152-000.....	82
AFF204-416-040.....	25	AHI010-416-045.....	28, 76, 94	ANE835-202-000.....	82
AFF204-416-060.....	74	AHI010-416-065.....	76	APA120-000-010.....	121
AFF204-423-040.....	25	AHI010-423-045.....	28	APA120-000-020.....	121
AFF204-430-040.....	25	AHI020-410-045.....	28, 76, 94, 106	APA120-000-030.....	121
AFF204-610-028.....	93	AHI020-410-065.....	76	APA120-000-040.....	121
AFF204-610-040.....	25	AHI020-413-045.....	28, 76, 94	APA120-000-050.....	121
AFF204-610-060.....	74	AHI020-413-065.....	76	APA120-000-110.....	121
AFF204-616-028.....	93	AHI020-416-045.....	28, 28, 30, 76, 94	APA120-000-200.....	121
AFF204-616-040.....	25	AHI020-416-065.....	76	APA120-000-210.....	121
AFF204-616-060.....	74	AHI020-423-045.....	28	ARS010-011-187.....	97
AFF204-623-040.....	25	AHI020-426-045.....	28	ARS010-013-187.....	96, 107
AFF204-630-040.....	25	AHI020-430-045.....	28	ARS010-019-302.....	40
AFF205-223-040.....	26	AHI020-433-045.....	28	ARS010-024-302.....	34
AFF205-423-040.....	26	AHI030-416-045.....	28, 76, 94	ARS010-027-302.....	34
AFF205-623-040.....	26	AHI030-416-065.....	76	ARS020-024-302.....	35, 54
AFF208-216-040.....	25	AHI030-423-045.....	28	ARS020-027-302.....	35, 54
AFF208-216-060.....	74, 78, 79	AHI030-430-045.....	28	ARS030-026-302.....	35, 54
AFF208-416-040.....	25	AHI110-000-000.....	27	ARS030-028-302.....	35, 54
AFF208-416-060.....	74	AHI110-416-050.....	27	ARS032-026-302.....	35, 54
AFF208-616-040.....	25	AHI110-423-050.....	27	ARS034-026-302.....	35, 54



Numerisch / Numerical

ARS036-026-302	35, 54	ARS160-011-187	99	AUT080-011-187	103
ARS050-019-302	41, 48	ARS160-013-187	99, 107	AUT080-013-187	102
ARS050-024-302	36, 47, 55	ARS160-019-302	44, 48	AUT080-017-302	65, 66
ARS050-027-302	36, 55	ARS160-024-302	39, 47	AUT080-021-302	61, 62, 69
ARS060-022-302	41, 48	ARS170-011-187	99	AUT084-021-302	62
ARS060-026-302	36, 47, 55	ARS170-013-187	99	AUT086-021-302	62
ARS060-028-302	36, 55	ARS170-024-302	39	AUT090-027-187	96, 97, 102, 103, 108
ARS062-026-302	36, 55	ARS180-011-187	99	AUT090-029-302	65
ARS064-026-302	36, 55	ARS180-013-187	99, 107	AUT090-040-302	56, 61, 69
ARS066-026-302	36, 55	ARS180-019-302	44, 48	AUT150-011-187	103, 105
ARS080-011-187	97	ARS180-024-302	39	AUT150-013-187	102, 105, 108
ARS080-013-187	96	ARS182-024-302	39	AUT150-017-302	65, 68
ARS080-019-302	40-42, 48	ARS184-019-302	44, 48	AUT150-021-302	61, 64, 69
ARS080-024-302	34-37, 47, 54, 55	ARS184-024-302	39, 47	AUT152-017-302	68
ARS080-027-302	34-37, 54, 55	ARS186-024-302	39	AUT152-021-302	64, 69
ARS082-024-302	37	ARS190-024-302	39	AUT160-011-187	105
ARS082-027-302	37	ARS192-024-302	39	AUT160-013-187	105, 108
ARS084-019-302	42	ARS200-024-302	39	AUT160-017-302	68
ARS084-024-302	37	ARS200-027-302	39	AUT160-021-302	64, 69
ARS084-027-302	37	ARS202-024-302	39, 47	AUT170-011-187	105
ARS086-024-302	37	ARS202-027-302	39	AUT170-013-187	105, 108
ARS086-027-302	37	ARS220-024-302	39	AUT170-017-302	68
ARS100-027-187		ARS220-027-302	39	AUT170-021-302	64, 69
.....	96-98, 102-104, 107, 108	ARS300-040-302	54, 55	AUT174-011-187	105
ARS100-029-302	40, 41, 43, 48, 65	ARS300-140-302	54, 55	AUT174-013-187	105, 108
ARS100-040-302	34-36, 47, 61, 69	ARS330-040-302	57	AUT180-021-302	64, 69
ARS102-029-302	43	ASE280-020-010	30		
ARS102-040-302	38	ASE280-020-040	106		
ARS110-029-302	43	ASE280-030-010	48		
ARS110-040-302	38	ASE280-030-020	47		
ARS112-029-302	43	ASE280-030-040	107		
ARS112-040-302	38	ASE280-040-010	69		
ARS150-011-187	97, 99	ASE280-040-040	108		
ARS150-013-187	96, 99, 107	ASE280-050-010	78		
ARS150-019-302	40, 41, 44, 48	ASE280-050-020	79		
ARS150-024-302	34, 35, 36, 39, 47	ASE280-060-010	86		
ARS150-027-302	39	AUR810-000-000	72, 78		
ARS152-011-187	99	AUT010-011-187	103		
ARS152-013-187	99	AUT010-013-187	102, 108		
ARS152-024-302	39	AUT010-017-302	65		
ARS152-027-302	39	AUT010-021-302	61, 69		
ARS154-019-302	44	AUT030-025-302	62		
ARS154-024-302	39	AUT040-017-302	66		
ARS154-027-302	39	AUT040-021-302	62, 69		

